



iMX105 BD Pyxis™ ES Refrigerator

Service and Maintenance Manual

April 2024
360394 REV G

Document History

| Revision | Date | CO | Supersession | Revision Description |
|----------|-------------|-------|----------------|---|
| A | 17 AUG 2018 | 13878 | n/a | Initial release. |
| B | 14 MAR 2019 | 14392 | B supersedes A | <ul style="list-style-type: none"> Reformat to include white space and update precautionary symbols and notifications. Update instruction for manual bypass lock operation check. Add replace putty task to preventive maintenance schedule. Update lower rail setting in Default Settings table. |
| C | 7 OCT 2019 | 14958 | C supersedes B | <ul style="list-style-type: none"> Add information for 220-240V 50/60Hz models. Updated instruction for lubricating hinges. |
| D | 7 JAN 2020 | 15198 | D supersedes C | <ul style="list-style-type: none"> Update parts tables to include new part numbers for 230V models. |
| E | 15 APR 2022 | 16798 | E supersedes D | <ul style="list-style-type: none"> Updated PM Schedule Added Determine Control Probe Offset instructions. Removed Lubricate Upper and Lower Door Hinge Cams section. Added pictures and updated text to cleaning Condenser Grill. Updated Troubleshooting table action for "Latch is Broken". Updated parts tables. Rotated Schematics pages. Updated the use of Notifications throughout the manual for consistency. |
| F | 03 APR 2024 | 27077 | F supersedes E | <ul style="list-style-type: none"> Updated content in the Intended Use section. Updated parts pages. Updated Regulatory Compliance section. |
| G | 11 APR 2024 | 27118 | G supersedes F | <ul style="list-style-type: none"> Updated Regulatory Compliance section. |

* Date submitted for Change Order review. Actual release date may vary.

Document Updates

The document is furnished for information use only, is subject to change without notice and should not be construed as a commitment by BD and Helmer Scientific. BD and Helmer Scientific assume no responsibility or liability for any errors or inaccuracies that may appear in the informational content contained in this material. For the purpose of clarity, BD and Helmer Scientific consider only the most recent revision of this document to be valid.

Notices and Disclaimers

Confidential / Proprietary Notices

Use of any portion(s) of this document to copy, translate, disassemble or decompile, or create or attempt to create by reverse engineering or otherwise replicate the information from BD and Helmer Scientific products is expressly prohibited.

Copyright and Trademark

Copyright © 2024 BD. BD, the BD Logo, and Pyxis are trademarks of Becton, Dickinson and Company.

Helmer is a registered trademark of Helmer, Inc. in the United States of America. All other trademarks and registered trademarks are the property of their respective owners.

Disclaimer

This manual is intended as a guide to provide the operator with necessary instructions on the proper use and maintenance of certain BD and Helmer Scientific products.

Any failure to follow the instructions as described could result in impaired product function, injury to the operator or others, or void applicable product warranties. BD and Helmer Scientific accept no responsibility for liability resulting from improper use or maintenance of its products.

The screenshots and component images appearing in this guide are provided for illustrative purposes only, and may vary slightly from the actual software screens and/or product components.

Helmer Scientific
14400 Bergen Boulevard
Noblesville, IN 46060 USA
www.helmerinc.com

Becton, Dickinson and Company
Franklin Lakes, NJ
United States
201.847.6800
BD.com

Contents

- 1 About this Manual 4**
 - 1.1 Intended Audience. 4
 - 1.2 Intended Use 4
 - 1.3 Safety Symbols and Precautions. 4
 - 1.4 Avoiding Injury 5
 - 1.5 Model and Input Power 6
 - 1.6 Product Labels. 6

- 2 Installation and Configuration 7**
 - 2.1 Location Requirements 7
 - 2.2 Placement and Leveling 7
 - 2.3 Connect Backup Power. 8
 - 2.4 Connect External Monitoring Devices 8
 - 2.5 Module Installation. 9
 - 2.6 Prepare for Monitoring. 9
 - 2.7 Configure Storage 10

- 3 Controls. 11**
 - 3.1 Home Screen. 11
 - 3.2 Home Screen Functions 11
 - 3.3 Alarm Reference 12
 - 3.4 Support Screen 12
 - 3.5 Settings 12

| | | |
|----------|-----------------------------------|-----------|
| 4 | Maintenance | 17 |
| 4.1 | Alarm Tests | 18 |
| 4.2 | Sensor Calibration | 19 |
| 4.3 | Upgrade System Firmware | 20 |
| 4.4 | Test and Replace Backup Batteries | 21 |
| 4.5 | LED Lamp Strip | 22 |
| 4.6 | Display Board Battery | 22 |
| 4.7 | Bypass Lock | 22 |
| 4.8 | Clean Refrigerator | 23 |
| 5 | Service | 26 |
| 5.1 | Refrigerant | 26 |
| 5.2 | CSV Download | 27 |
| 6 | Troubleshooting | 28 |
| 6.1 | Access System Problems | 28 |
| 6.2 | Chamber Temperature Problems | 29 |
| 6.3 | Alarm Problems | 29 |
| 6.4 | Condensation Problems | 30 |
| 7 | Parts | 31 |
| 8 | Schematics | 33 |
| 9 | Compliance | 35 |
| 9.1 | Regulatory Compliance | 35 |
| 9.2 | EMC Compliance | 35 |
| 9.3 | Manufacturer of Record | 35 |

1 About this Manual

1.1 Intended Audience

This manual is intended for use by end users of the iMX105 BD Pyxis ES Refrigerator Tower. For information on how to use the Pyxis MedStation™ ES which provides medication management capabilities to the iMX105 BD Pyxis ES Refrigerator, please refer to the Pyxis MedStation™ ES User Guide.

1.2 Intended Use

Note

This equipment has been tested and found to comply with the limits for a Class A digital device, pursuant to part 15 of the FCC Rules. These limits are designed to provide reasonable protection against harmful interference when the equipment is operated in a commercial environment. This equipment generates, uses and can radiate radio frequency energy and, if not installed and used in accordance with the instruction manual, may cause harmful interference to radio communications. Operation of this equipment in a residential area is likely to cause harmful interference in which case the user will be required to correct the interference at his own expense.

The iMX105 is intended for the storage of pharmaceuticals, vaccines and other medical and scientific products. The iMX105 supports CDC performance and feature recommendations for vaccine storage without the need for third-party digital data logger (DDL) equipment.

1.3 Safety Symbols and Precautions

The following symbols are used in this manual to emphasize certain details for the user:



Task Indicates procedures which need to be followed.



Note Provides useful information regarding a procedure or operating technique when using Helmer Scientific products.

NOTICE Advises the user against initiating an action or creating a situation which could result in damage to equipment; personal injury is unlikely.

The following symbols may be found on the refrigerator or refrigerator packaging:



Caution: Risk of damage to equipment or danger to operator



Earth / ground terminal



Caution: Hot surface



Protective earth / ground terminal



Caution: Shock / electrical hazard



Refer to documentation



Danger: Risk of Fire or Explosion
Flammable refrigerant used



Caution: Unlock all casters



Warning: Crushing of hands / fingers



Caution: Dispose of properly



Caution: Follow handling instructions carefully.



Danger: Repair only by trained service personnel.



Caution: Consult instruction manual prior to installation or service.



Danger: Do not use mechanical devices to defrost.



Pantone 185 (Red)
Warning: Refrigeration Line. Avoid puncturing or opening refrigeration circuit.



Caution: Follow handling instructions carefully in compliance with U.S. Government regulations

1.4 Avoiding Injury



- Do not use mechanical devices or other means to accelerate the defrosting process, other than those recommended by the manufacturer.
- Do not damage the refrigerant circuit.

Review safety instructions before installing, using, or maintaining the equipment.

- ◆ Before moving unit, ensure door is closed and casters (if installed) are unlocked and free of debris.
- ◆ Before moving unit, disconnect the AC power cord and secure the cord.
- ◆ Never physically restrict any moving component.
- ◆ Avoid removing electrical service panels and access panels unless so instructed.
- ◆ Keep hands away from pinch points when closing the door.
- ◆ Avoid sharp edges when working inside the electrical compartment and refrigeration compartment.
- ◆ Avoid staring into the bin illumination LEDs for extended periods of time as eye injury may occur.
- ◆ Ensure pharmaceutical products are stored at recommended temperatures determined by standards, literature, or good laboratory practices.
- ◆ Proceed with caution when adding and removing product from the refrigerator.
- ◆ Do not open multiple, loaded bins at the same time.
- ◆ Use manufacturer supplied power cord only.
- ◆ Avoid risk of ignition by using only manufacturer supplied components and authorized personnel when servicing the unit.
- ◆ Using the equipment in a manner not specified by the manufacturer may impair the protection provided by the equipment.
- ◆ Ensure product is stored safely, in accordance with all applicable organizational, regulatory, and legal requirements.
- ◆ The refrigerator is not considered to be a storage cabinet for flammable or hazardous materials.
- ◆ **REQUIRED:** Decontaminate parts prior to sending for service or repair. Contact Pyxis Technical Support Center at BD-Pyxis-Support@bd.com or 800-727-6102.

1.5 Model and Input Power

Note

Service information varies depending on the model and power requirements.

Table 1. Model and Input Power

| Model | Voltage | Frequency | Current Draw |
|-------|---------|-----------|--------------|
| 105 | 115V | 60 Hz | 1.4 A |
| | 220-240 | 50/60 Hz | 0.85 A |

* Amperage values are subject to change. Refer to the product specification label on your unit for current values.

1.6 Product Labels

This information appears on the product specification label, located on the rear of the refrigerator. The model also appears on a label located in the chamber on the upper side of the right wall.

Note

Information contained in this specification label varies depending on the model and power requirements.

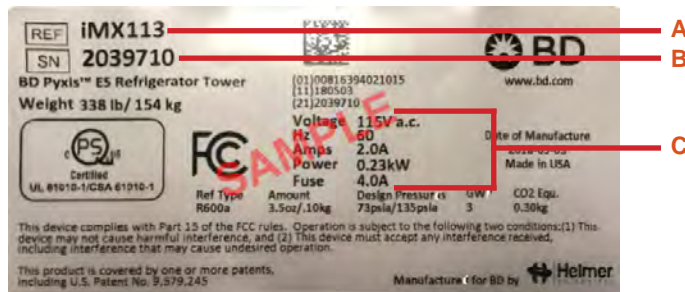

| Label | Description |
|-------|--------------------|
| A | Model (REF) |
| B | Serial number |
| C | Power requirements |

Sample Product Specification label.

(For illustration only; regulatory information and other content shown here may differ from that on the equipment label)

2 Installation and Configuration

2.1 Location Requirements



Keep all ventilation openings in the enclosure or, in the structure for building-in, clear of obstruction.

- ◆ Has a grounded outlet meeting the electrical requirements listed on the product specification label.
- ◆ Is clear of direct sunlight, high temperature sources, heating vents, and air conditioning vents.
- ◆ Has a minimum of 3" (76 mm) of space behind the refrigerator for clearance and feature access.
- ◆ Meets the limits specified for ambient temperature (15 °C to 32 °C) and relative humidity.

2.2 Placement and Leveling

NOTICE

- To prevent tipping, ensure the casters (if installed) are unlocked and the door is closed before moving the refrigerator.
 - Use of leveling feet or casters is required.
 - Do not sit, lean, push or place heavy objects on top surface.
 - Do not lean or push down on an open door.
 - To avoid damaging refrigerant tubing or risking refrigerant leak, use caution when moving or operating the unit.
1. Remove the refrigerator from the shipping carton.
 2. Remove the accessory package from inside the refrigerator.
 3. Remove and discard the interior packing material.
 4. Ensure door is secured.
 5. Move refrigerator into place.
 6. Adjust leveling legs as needed to ensure refrigerator is level or lock casters (if installed).
 7. Ensure bins are locked in place within the modules.

2.3 Connect Backup Power

The iMX105 BD Pyxis™ ES Refrigerator is equipped with a backup battery system. The backup battery is located below the chamber, behind the right-side access panel. The backup battery system provides electrical power to the i.C³ temperature monitoring system, alarm system, and magnetic door lock. Switch the backup battery key switch ON to provide the monitoring system and magnetic lock with backup power in the event of AC power failure.

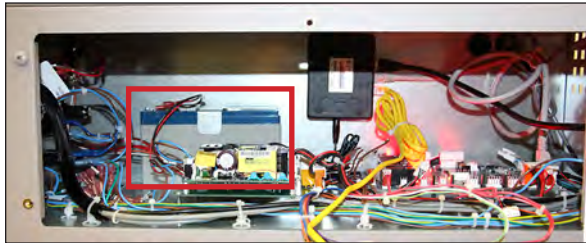

Monitoring system backup battery.

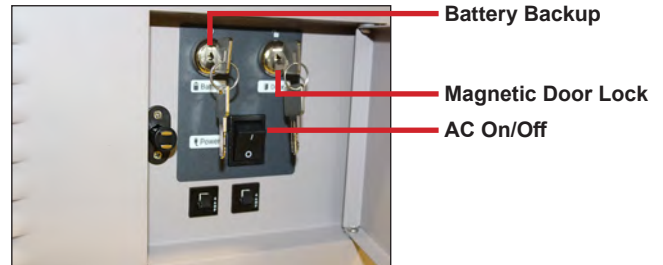

Battery life varies by manufacturer as well as voltage level remaining. Providing full power is available, backup power for the magnetic door lock is available for up to 2 hours.

NOTICE

Before installing or replacing batteries, switch AC power OFF and turn the backup battery key switch OFF. Disconnect refrigerator from AC power.

Notes

- The magnetic door lock uses the monitoring system backup battery for backup power in the event of power failure.
- The monitoring system will start on backup battery power alone. If the refrigerator was not previously connected to AC power and the backup battery is switched on, the monitoring system will begin running on backup battery power.
- If AC power is lost, the monitoring system will automatically disable some features to prolong backup battery power. Data collection will continue until backup battery power is depleted.

2.4 Connect External Monitoring Devices

The remote alarm interface is a relay switch with three terminals:

- ◆ Common (COM)
- ◆ Normally Open (NO)
- ◆ Normally Closed (NC)

Terminals are dry contacts and do not supply voltage. Interface circuit is either normally open or normally closed, depending on terminals used.

Requirements for your alarm system determine which alarm wires must connect to terminals.

NOTICE

- The interface on the remote alarm monitoring system is intended for connection to the end user's central alarm system(s) that uses normally-open or normally-closed dry contacts.
- If an external power supply exceeding 33 V (RMS) or 30 V (DC) is connected to the remote alarm monitoring system's circuit, the remote alarm will not function properly and may cause damage to the control board or result in injury to the user.

The terminals on the remote alarm interface have the following maximum load capacity:

- ◆ 1.0 A at 33 V (AC) RMS or 30 V (DC)

Connect to the Alarm Interface

1. Locate the remote alarm terminals on the back of the unit at the lower left side.
2. Using a #2 Phillips screwdriver, connect remote alarm wires to appropriate terminals, according to requirements for your alarm system.
3. Use a cable tie to relieve strain on alarm wires (if necessary).



2.5 Module Installation



Standard Module

i Notes

- The quantity and size of modules added will depend on the current configuration of the unit and space available.
- The initial module must be installed and secured at the floor of the cabinet. Additional modules can be stacked above and secured, one at a time.
- Ensure each module is secured in the cabinet prior to installing subsequent module(s).

NOTICE

- Failure to install a plenum in the absence of a module could cause a disruption in air circulation and impede temperature uniformity.
- To prevent operation failure, the rotary switch on the module power control board **MUST** be set to the correct address number indicating the location before installation of the module within the cabinet. (Modules are numbered from bottom to top with the module on the floor of the cabinet being in the 1 position.)
- Failure to properly set the Tray Type selection switch (S6) on the module power control board **prior** to installation will cause an error condition on the MedStation. A Standard Bin is Single (SNGL), a Deep Bin is Double (DBL).
- Use caution when installing additional modules to avoid pinching fingers or hands between modules.

Modules can be added to the BD Pyxis™ ES Refrigerator for additional compartmentalized storage. Module service kits are available in standard and deep sizes. Contact Pyxis Technical Support Center for module service kits. Installation instructions are provided with the service kit.

2.6 Prepare for Monitoring

The backup battery key switch is switched OFF for shipping. Turn the backup battery key switch to ON to provide the monitoring system with power in the event of AC power failure.

Temperature Probes

Three types of temperature probes are included in the BD Pyxis™ ES Refrigerator: primary monitor probe, condenser probe and control probe.

The iMX105 refrigerator includes a solid ballast installed on the interior upper left side of the unit. The primary monitor probe is inserted into the solid ballast and secured with thumb screws. Additional probes may be added through the rear port.

i Notes

Temperature probes are fragile; handle with care.

✓ Install Additional Probe Through Rear Port

1. Peel back putty to expose port.
2. Insert probe through rear port into chamber.
3. Loosen the thumb screw and insert probe into open probe hole in solid ballast.
4. Ensure probe is bottomed into probe hole.
5. Secure probe with thumb screw until probe is snug. Take care not to overtighten.
6. Replace putty, ensuring a tight seal.

2.7 Configure Storage

NOTICE

Before moving bins, ensure they are completely empty for safe removal.

Notes

- Before moving storage components, protect stored items in refrigerator from extended exposure to adverse temperature.
- Products stacked against back wall may obstruct air flow and affect performance of unit.

Product Loading Guidelines

When loading your refrigerator, take care to observe the following guidelines:

- ◆ Never load refrigerator beyond capacity.
- ◆ Always store items within shelves or bins.
- ◆ Temperature uniformity is maintained by air circulation, which could be impeded if unit is overfilled, particularly at the top or back. Ensure proper clearance is provided below the fan and between stored product.

Foam Bin Inserts

Foam inserts may be added to standard or deep bins to provide separation between stored products. Contact Pyxis Technical Support Center for Foam Insert service kits.

Install Foam Inserts

1. Insert large foam block into bin and slide to rear and beneath bin cover.
2. Install remaining foam pieces vertically to create desired space.

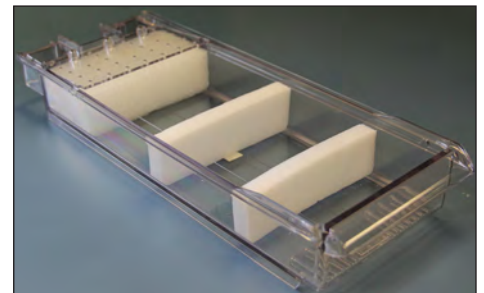

Shelves

Note

The shelf attached directly to the top module is not adjustable.

Remove Shelf

1. With one hand, lift front edge of the shelf from the front brackets.
2. With the other hand, reach under the shelf and bump rear edge of the shelf upward to disengage rear brackets.

Install Shelf

1. Insert shelf into chamber, placing it on brackets.
2. Gently bump rear edge of the shelf downward to engage brackets.
3. Pulling shelf forward gently; shelf should not disengage from rear brackets.

Move Shelf Brackets

1. Using a screwdriver, remove front bracket retainers.
2. Tap front brackets upward to disengage standards.
3. Remove front brackets from standards.
4. Insert front brackets into standard at appropriate height.
5. Tap front brackets downward to engage standards.
6. Using a screwdriver, install front bracket retainers.

3 Controls

The iMX105 BD Pyxis™ ES Refrigerator is equipped with the i.C³ temperature monitoring and control system. The i.C³ system combines temperature control and monitoring into a single user interface.

3.1 Home Screen

The Home Screen is the default screen and is displayed during normal operation and when a user is not interfacing directly with the i.C³.

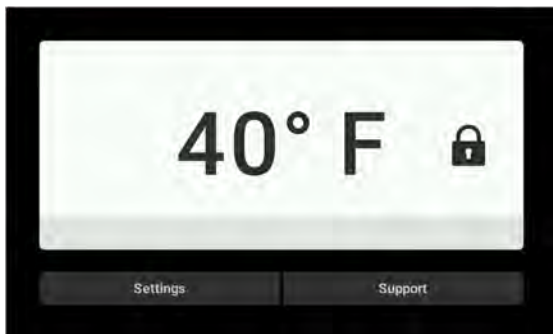

Home Screen (with door lock active)

3.2 Home Screen Functions

- ◆ View current interior cabinet temperature readings
- ◆ View door lock status
- ◆ View alarm condition
- ◆ Access contact and device information
- ◆ Access device settings

3.3 Alarm Reference

If an alarm condition is met, an alarm activates. Alarms default to visual only through the i.C³ display.

Table 2. Alarm Reference

| Alarm | Alarm |
|-----------------------------|-----------------------------------|
| Compressor probe failure | Low battery voltage |
| Compressor high temperature | Backup battery failure |
| Control probe failure | Main power failure |
| Drive space low | Primary temperature probe failure |
| Drive space full | Over maximum temperature limit |
| Door open (Time) | Below minimum temperature limit |
| Inverter communication lost | Communication failure |

3.4 Support Screen

The Support Screen provides contact information as well as access to device information. Select the **More Info** button to view additional device information or the **Exit** button to return to the home screen.

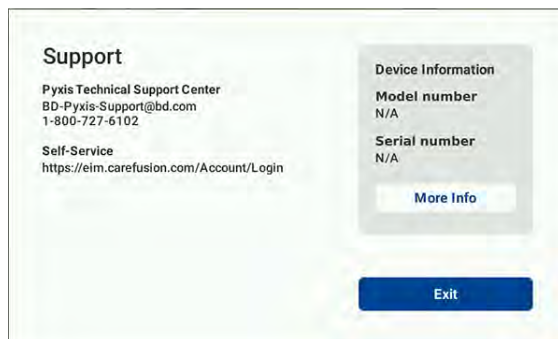

Support screen



Device Information screen (sample)

3.5 Settings

Through the i.C³ monitoring and control system, current settings may be viewed and changed. To view settings, touch the **Settings** button and enter the appropriate password. Use a touch-drag motion to scroll up or down to select the desired setting.

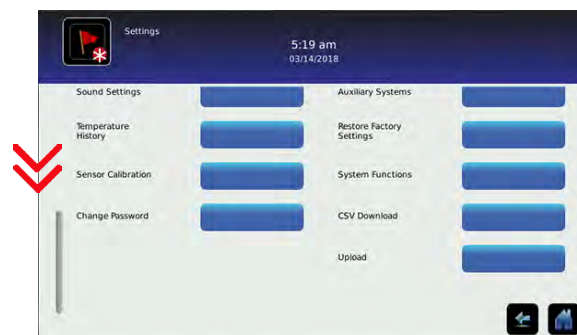
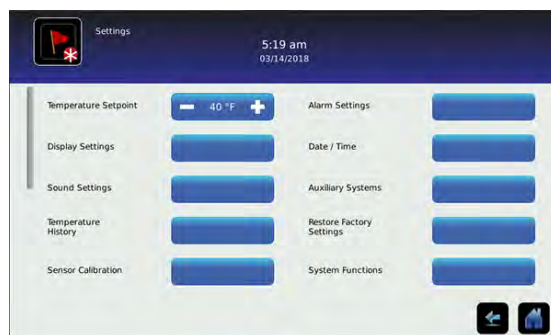

Settings screens (MedStation not connected)

i Notes

- The Settings screen is password protected. If viewing settings for the first time, enter factory default password of “1234”.
- Settings appearing in the column on the right are not visible when the BD Pyxis™ ES Refrigerator is connected to the MedStation.
- Changing temperature settings affects operation of the refrigerator. Do not change settings unless instructed in product documentation or by Technical Support.

The i.C³ temperature monitor and controller is programmed at the factory. To change a setting, first enter the Settings screen, then select the setting.

Temperature Setpoint

The setpoint is the temperature at which the refrigerator operates.

Notes

- The Settings screen is password protected. If viewing settings for the first time, enter factory default password of “1234”.
- Change the setpoint if your organization requires a chamber temperature other than 40 °F.

Change Temperature Setpoint

1. From the Home screen, select the Settings button. The password numeric keypad is displayed.
2. Enter the password. (*If accessing for the first time, use the factory default password.*) The Settings screen is displayed.
3. Touch (+) or (-) on the Temperature Setpoint spin box to change the value.

Display Settings

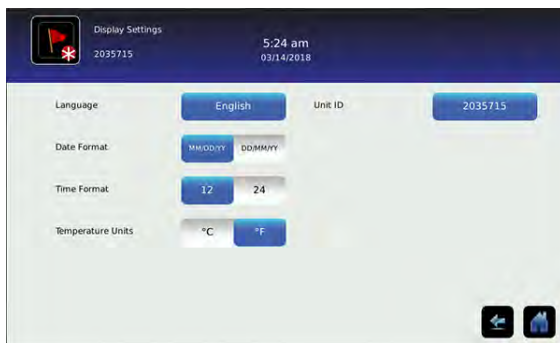

Display Settings provides options for formatting the i.C³ display. Language, date and time format, and temperature units can be selected. The Unit ID may also be viewed and changed.

Sound Settings

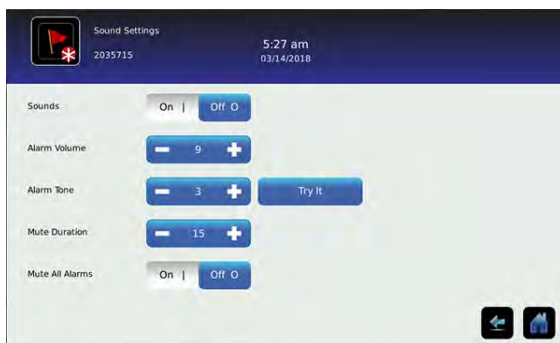

The Sounds Settings screen allows the user to turn sounds on or off, change the alarm tone and volume, and mute active alarms.

Temperature History

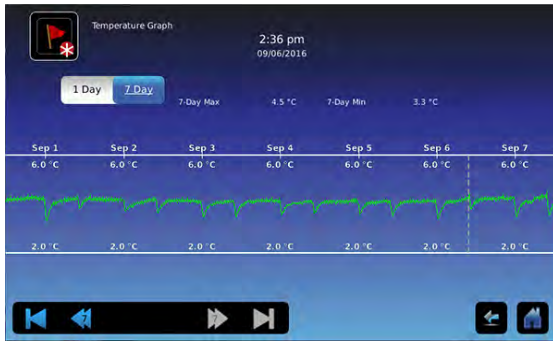

The Temperature History screen displays a graph showing the temperature history of the Primary Monitor probe. The graph may be viewed in a one-day or seven-day format. The zoom feature may be used to allow a more detailed view of a particular segment of the temperature graph. The user may also view specific temperature information using the one touch quick information feature.

Using Zoom Feature

1. Touch and draw a box around the desired area on the temperature graph. The selected area will appear in the display.
2. Touch the check mark to return the expanded view.

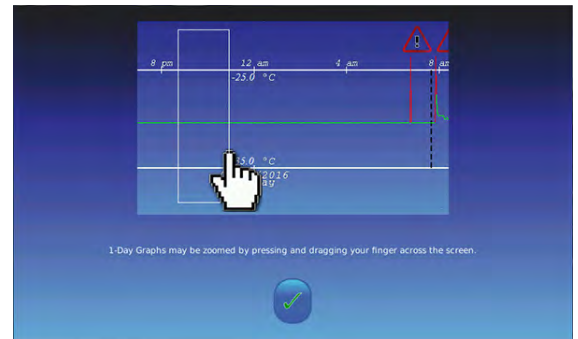

Using One Touch

1. Touch the desired point on the graph. A dialog box will appear providing selected date, time and temperature data.

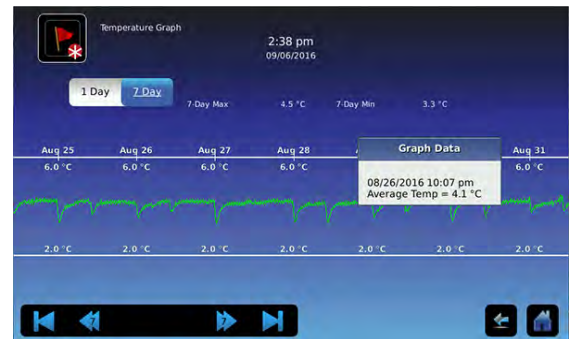

Change Password

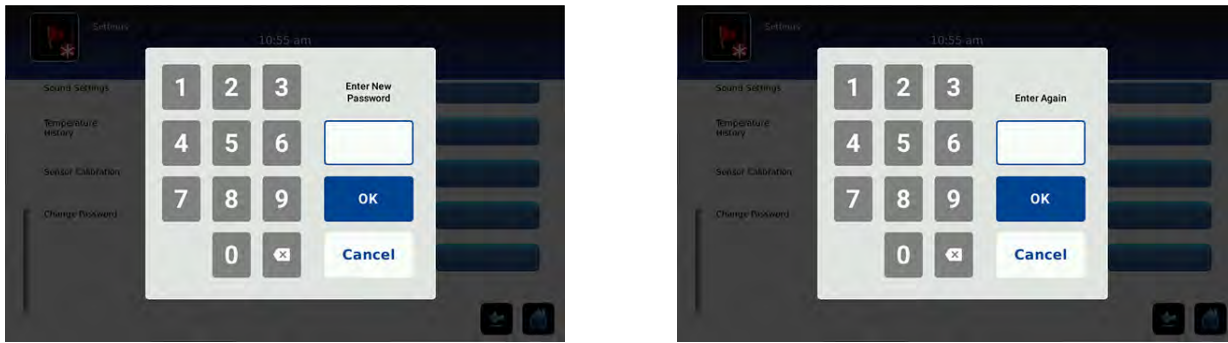

The Administrator password can be changed by selecting the Change Password button.

Notes

- The factory preset password is “1234”.
- Once the password is changed, ensure the new password is recorded and kept in a safe place.

Changing Administrator Password

1. From the Settings screen, select the Change Password button. A numeric keyboard appears.
2. Enter a four-digit number and press the OK button.
3. Re-enter the four-digit number to confirm, and press the OK button to save the new password.

Factory Default Settings

Settings listed below may be simultaneously returned to factory default values.

NOTICE

Ethernet port must be ON to communicate with the MedStation.

Note

Some factory default settings may not be the same as the settings that were factory-calibrated before the refrigerator was shipped.

Table 3. Default Settings

| Setting | Restored Value |
|--|--|
| Display Brightness | High (3 symbols) |
| Administrator Password (for Settings screen) | 1234 |
| Sounds | On |
| Alarm Volume | 9 |
| Alarm Tone | 3 |
| Mute All Alarms | On |
| Mute Duration (minutes) | 15 |
| Temperature Calibration Values | Not affected (values previously entered during setup) |
| Unit ID | Not affected (previously selected during setup) |
| Date Format | MM/DD/YYYY |
| Day | Not affected (maintained in real-time clock) |
| Month | |
| Year | |
| Time Format | 12-hour |
| Minute | Not affected (maintained in real-time clock) |
| Hour | |
| AM/PM | |
| Language | Not affected (Language previously selected during setup) |
| Temperature Units | °F |
| Password Protection (for Settings screen) | On |
| USB Port | Off |
| Ethernet Port | On |
| High Temperature Alarm Setpoint | 43 °F |
| High Temperature Alarm Time Delay | 0 minutes |
| Low Temperature Alarm Setpoint | 36 °F |
| Low Temperature Alarm Time Delay | 0 minutes |
| Power Failure Alarm Time Delay | 1 minute |
| Probe Failure Alarm Time Delay | 0 minutes |
| Door Open (Time) Alarm Time Delay | 3 minutes |
| Compressor Temperature Alarm Setpoint | 122 °F |
| Compressor Temperature Alarm Time Delay | 0 minutes |
| Chamber Setpoint | 40 °F |
| Upper Rail Setpoint | 1.3 °F |
| Lower Rail Setpoint | -1.3 °F |
| Delay on Start-Up | 2 minutes |

Restore Settings:

1. Touch the **Settings** icon.
2. Scroll down and touch the **Restore Factory Settings** button. The Restore Factory Settings confirmation box appears.
3. Touch to restore the factory settings or to maintain the current settings and clear the message.

4 Maintenance

Maintenance tasks should be completed according to the schedule below.

NOTICE

Maintenance should only be performed by trained refrigeration technicians.

Notes

- The preventive maintenance schedule provides recommended minimum requirements. Regulations or physical conditions at your organization may require maintenance items be performed more frequently, or only by designated service personnel.
- Before performing maintenance, protect items in refrigerator from extended exposure to adverse temperature.
- Allow refrigerator temperature to stabilize at setpoint after performing service or after extended door opening.

Table 4. Preventive Maintenance Schedule

| Task | Frequency | | | |
|--|-----------|---------|---------|-----------|
| | 1 year | 2 years | 5 years | As Needed |
| Test the high temperature (<i>over maximum temperature limit</i>) and low temperature (<i>below minimum temperature limit</i>) alarms (<i>as required by your organization's protocols</i>). | | | | ✓ |
| Test the power failure alarm (<i>as required by your organization's protocols</i>). | | | | ✓ |
| Test the door alarm (<i>as required by your organization's protocols</i>). | | | | ✓ |
| Verify the temperature calibration on the monitor and change it if necessary. | ✓ | | | |
| Replace monitoring system backup battery | | ✓ | | |
| Check the chamber lights and replace if necessary. | | | | ✓ |
| Replace putty covering wire routing hole between internal cabinet and unit base. | | | ✓ | |
| Replace Display Board CR2032 battery. | | | | ✓ |
| Check the manual bypass lock operation. | | | ✓ | |
| Clean the door gaskets, interior, and exterior of the refrigerator. | | | | ✓ |
| Clean the condenser grill. | | | | ✓ |

i Notes

- During a power failure the backup battery provides power to the monitoring system, power failure alarm, and magnetic lock. If the backup battery is not functioning, the power failure alarm will not be activated and the battery should be replaced.
- During a power failure, the backup battery continues to provide power to the magnetic lock. If the backup battery is not functioning, the magnetic lock will not secure the door.

4.1 Alarm Tests

Test alarms to ensure they are working correctly. The BD Pyxis™ ES refrigerator has alarms for chamber temperature, compressor temperature, power failure, probe failure, and door open (time). Alarms can only be tested when the refrigerator is not connected and communicating with the MedStation. To initiate alarm tests, touch the **Settings** button then select **Alarm Settings**.

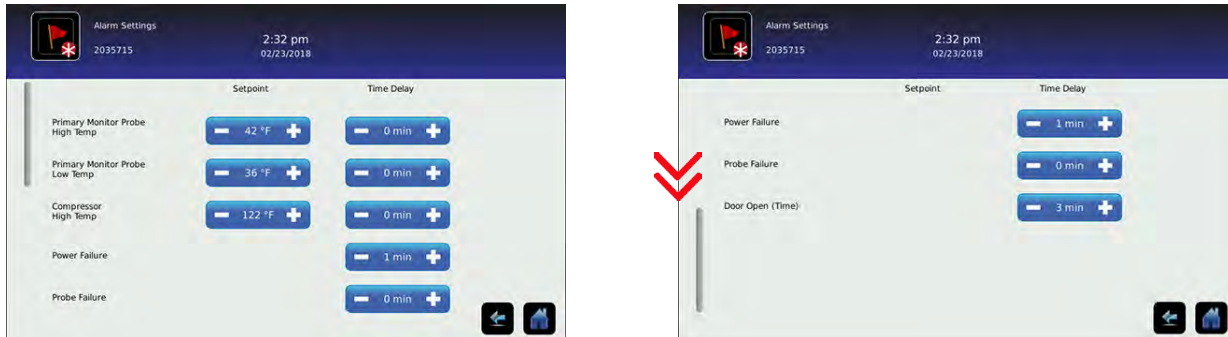

Manual Chamber Alarm Test

NOTICE

- Perform the low alarm test before the high alarm test to control the temperature more closely and complete the testing more quickly.
- Before testing alarms, protect items in the unit from extended exposure to adverse temperature.
- Temperature probes are fragile; handle with care.

i Test the Low Alarm (Below minimum temperature limit):

1. Identify setting for low alarm setpoint.
2. Loosen the thumbscrew securing the primary monitor probe in the ballast and remove the probe.
3. Immerse probe in glass filled with water that is approximately 40 °F. Slowly add crushed ice to lower temperature.
4. When low temperature alarm appears on the display, note the temperature on the i.C³ display.
5. Compare the temperature at which the alarm appears on the display to the low alarm setpoint.

i Test the High Alarm (Over maximum temperature limit):

1. Identify setting for high alarm setpoint.
2. Immerse probe in glass filled with water that is approximately 40 °F. Slowly add warm water to raise temperature.
3. When high temperature alarm appears on the display, note the temperature on the i.C³ display.
4. Compare the temperature at which the alarm appears on the display to the high alarm setpoint.
5. Remove probe from warm water.
6. Place primary monitor probe in the ballast and secure with thumbscrew taking care not to overtighten.

Power Failure Alarm Test

Note

During a power failure, the power failure alarm appears and the battery provides power to the monitoring system and magnetic lock.

1. Change the Power Failure delay setting to 0 minutes by touching + or – on the Power Failure spin box to change the value to 0.
2. Switch AC ON/OFF switch OFF. Power failure alarm will appear on the monitor immediately.
3. Switch AC ON/OFF switch ON. Power failure alarm will clear.
4. Change Power Failure time delay to the original setting.

Door Open Alarm Test

1. Turn Door key switch to OFF.
2. Change the Door Open (Time) delay setting to 0 minutes by touching + or – on the Door Open spin box to change the value to 0.
3. Open door. Alarm will activate immediately.
4. Close door. Alarm will clear.
5. Change Door Open (Time) delay to the original setting.

4.2 Sensor Calibration

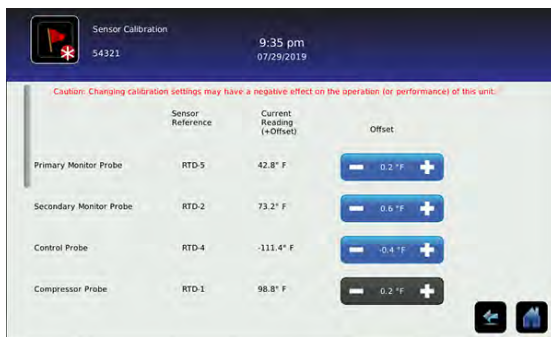

Sensor calibration values are programmed at the factory. Calibration values can be viewed and changed through the i.C³ monitoring and control system.

Notes

- The Settings screen is password protected. If viewing settings for the first time, enter factory default password of “1234”.
- Offset values are adjusted to the tenth of a degree (0.1).
- The Compressor Probe offset is factory-preset and should not be changed unless directed by Technical Support.

View Sensor Calibration Values

1. Touch Settings.
2. Enter the Settings password.
3. Touch Sensor Calibration. Sensor offset values and their current temperature readings are displayed.
4. Touch Home to return to the Home screen.

Note

Using putty to seal the probe hole when using a thermocouple wire to calibrate is recommended.

Calibrate Primary Monitor Probe

1. Ensure the Primary Monitor Probe is securely installed in the ballast.
2. Place a calibrated independent reference thermometer in one of the remaining probe holes in the ballast and tighten thumb screw to secure. (Take care not to over-tighten the thumb screw,) This may involve temporarily removing an additional probe to provide an opening for the independent reference thermometer.
3. Close the door and allow the chamber temperature to stabilize.
4. Observe and note the thermometer temperature. If the independent thermometer corresponds to the displayed temperature, proceed to Step 6.
5. Adjust the Primary Monitor Probe offset value higher or lower to reflect the difference between the chamber temperature displayed on the monitor and the temperature reading from the calibrated reference thermometer.
6. Loosen the thumb screw and remove calibrated independent reference thermometer from ballast.
7. Replace any additional probe that may have been removed previously, and tighten the thumb screw ensuring a snug fit.
8. Replace any removed putty.

Determine Control Probe Offset**NOTICE**

- Control Probe Offset is factory-preset and should not be changed. Contact Pyxis Technical Support Center for instructions regarding changing the Control Sensor Offset.
- Monitor temperature must be verified and accurate prior to adjusting the Control Sensor Offset.

1. View and record the Refrigerator Setpoint.
2. Allow unit to run with calibrated monitor temperature for several compressor cycles, and record the average monitor temperature.
3. View and record the current Control Offset value.
4. Subtract the Refrigerator Setpoint from the average monitor temperature and record the difference.
5. Add the current Control Offset value to the recorded difference determined in the previous step to establish the new Control Offset value.

| Example 1 | Example 2 |
|---|--|
| Refrigerator setpoint is 4.0 | Refrigerator setpoint is 4.0 |
| Average monitor temperature is 5.2 | Average monitor temperature is 2.8 |
| Current Control Offset is 0.3 | Current Control Offset is 0.3 |
| Subtract: $5.2 - 4.0 = 1.2$ (difference between average temperature and setpoint) | Subtract: $2.8 - 4.0 = -1.2$ (difference between average temperature and setpoint) |
| Add: $0.3 + 1.2 = 1.5$ (new control offset value) | Add: $0.3 + (-1.2) = -0.9$ (new control offset value) |

Enter New Offset Value:

1. Touch **i.C³ APPS, Settings**.
2. Enter the Settings password (default password is "1234").
3. Touch **Sensor Calibration**.
4. Touch minus (-) or plus (+) on the **Control Probe Offset** spin box.
 - ◆ Raise the offset value to lower chamber temperature; lower the offset value to raise chamber temperature.
5. Touch **Home** to return to home screen.

4.3 Upgrade System Firmware

Helmer may occasionally issue updates for the i.C³ firmware. Follow upgrade instructions included with the firmware update.

4.4 Test and Replace Backup Batteries

Notes

- The i.C³ Monitoring and Control System use the same backup battery.
- Use only a battery which meets manufacturer's specifications.

i.C³ Monitoring and Control System Backup Battery

An alarm message will appear at the top of the screen when the system is running on battery power. The monitoring system will automatically disable some features to extend battery life.

Check the Backup Battery

1. Ensure battery key switch is set to ON.
2. Switch AC ON/OFF switch OFF.
3. The screen should continue to display information with reduced brightness and the battery icon will appear on the screen. If the display is blank, replace the battery.
4. When completed, switch AC ON/OFF switch ON.

NOTICE

Take care not to short battery terminals to bracket or to each other when removing or attaching terminal connectors, bracket or bracket screws.

Remove and Replace Battery

1. Switch the main power switch to OFF; switch the battery backup and maglock key switches to OFF; disconnect the AC power cord from the power receptacle.
2. Use #2 Phillips screwdriver to remove the top and bottom center screws and loosen the 4 screws in the corners of the right-side panel.
3. Slide the cover upward to disengage the 4 screws from the keyhole openings and carefully rotate the panel outward.
4. Locate 12V Battery, remove wires from terminals and remove screws using #2 Phillips screwdriver for mounting bracket. Remove the old battery.
5. Place the new battery in the same location as the one removed.
6. Install the bracket over the battery and secure with (2) screws.
7. Reconnect the wires to the correct terminals.
8. Reinstall the right-side panel by placing the keyhole openings in the 4 corners of the panel over the 4 screws and slide downward making sure not to pinch wires between the panel and the base of the unit. Tighten screws using a #2 Phillips screwdriver.
9. Install the remaining 2 screws and tighten.
10. Reconnect the AC power cord; switch the main power switch to ON; switch the battery backup and maglock key switches to ON.

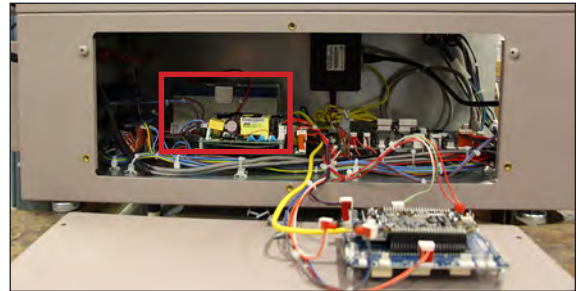

4.5 LED Lamp Strip

Check LED Lamp Strip

Ensure the chamber light turns on when the refrigerator door is opened.

Remove and Replace LED Lamp Strip

1. Switch the main power switch to OFF; switch the battery backup and maglock key switches to OFF; disconnect the AC power cord from the power receptacle.
2. Gently pinch together the outer edges of the plastic light cover and remove.
3. Loosen (2) screws on the top of the cabinet and slide the light fixture so the keyhole openings are disengaged from the screws and remove the fixture.
4. Disconnect the power wire from the circuit board.
5. Pull the circuit board off the mounting pegs and remove it from the unit.
6. Gently press the new circuit board onto the mounting pegs on the fixture in the same orientation as the one removed.
7. Connect the power wire to the new circuit board.
8. Align the keyhole openings in the fixture with the screws at the top of the cabinet and slide the fixture to engage the screws. Tighten screws using a #2 Phillips screwdriver.
9. Reinstall the plastic cover over the light fixture.
10. Reconnect the AC power cord; switch the main power switch to ON; switch the battery backup and maglock key switches to ON.

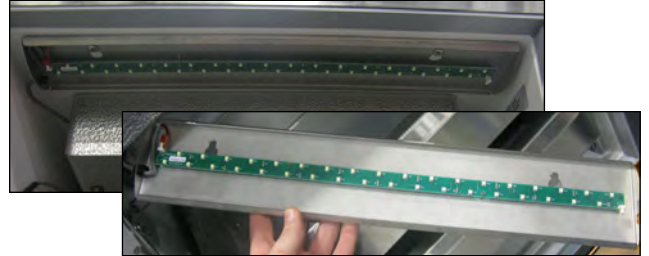

4.6 Display Board Battery

NOTICE

The display board is sensitive to static electricity and can be damaged by electrostatic discharge. Use proper ESD precautions when handling the display board.

Replace Display Board Battery

1. Switch the main power switch to OFF, switch the battery backup and electromagnetic lock door key switches to OFF; disconnect the AC power cord from the power receptacle.
2. Use #2 Phillips screwdriver to remove (2) screws from the bottom of the i.C³ bezel.
3. Gently lift the bezel to disconnect it from the mounting bracket on the front of the unit.
4. Locate the CR2032 battery and use a small flat head screwdriver to push the old battery out of the slot.
5. Install new CR2032 battery into the slot.
6. Mount bezel to cabinet using (2) screws.
7. Reconnect the AC power cord; switch the main power switch to ON; switch the battery backup and electromagnetic lock door key switches to ON. After the Home screen is displayed.
8. Allow the temperature to stabilize at the setpoint before moving inventory back into the unit.

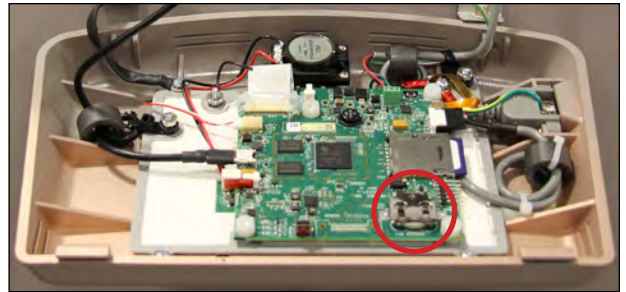

4.7 Bypass Lock

Check Manual Bypass Lock Operation

1. Open the exterior door.
2. Using the module assembly keys, unlock the manual release access cover.
3. Lift the cover upward to disengage the tabs and pull out to remove the cover and reveal the bin release lever(s).
4. Pull on the red manual release tab for each module and put in unlock state, then verify each bin can be pulled out.
5. Lift and place the manual release tab back in the locked state.
6. Push bins back into the modules and verify the bins are locked.
7. Replace the manual release cover by aligning the tabs on the cover with the slots in the bracket and slide downward to engage.
8. Push the locks in to lock the cover and close the refrigerator door.

4.8 Clean Refrigerator

To prevent damage to electrical components and to prevent the possibility of electric shock, safely shut down, turn off and unplug all BD Pyxis products before washing them. BD Pyxis products are typically cleaned with mild soap and warm water.

NOTICE

- When needed, clean the refrigerator with a damp cloth. Do not allow liquid to seep into any openings or seams. A nonabrasive cleanser can be used sparingly. Be sure to rinse off any residue with a clean, damp cloth. Avoid using spray bottles to spray into slots or ventilation openings.
- Do not leave behind a wet surface where dust may accumulate.

| Recommended cleaning solutions | |
|---|--|
| Mild detergent — per manufacturer's recommendation, as needed | Clorox Healthcare Bleach Germicidal Cleaner — no dilution required |
| 10% bleach solution — 1 part bleach to 9 parts water | Hibiclens — 25.6 oz/gallon water |
| 70% isopropyl alcohol (IPA) — no dilution required | LpH disinfectant cleaner — 0.5 oz/gallon water |
| Wex-Cide — 1 oz/gallon water | Maxima 128 — 1 oz/gallon water |
| Ready to Use Wex-Cide — no dilution required | MetriZyme — 1 oz/gallon water |
| Sani-Cloth Plus, Sani-Cloth Super, Sani-Cloth HB | Thymocide — no dilution required |
| Asepti-zyme — 1 oz/gallon water | Virkon — dilute per manufacturer's recommendation |
| Clorox wipes | |

| Acceptable hand sanitizers |
|---|
| Purell with 62% alcohol, no dilution required |
| 3M Avagard D, no dilution required |
| EcoLab Quik-Care, no dilution required |

Cabinet Exterior

Clean exterior surfaces with a soft cotton cloth and nonabrasive liquid cleaner ensuring liquids do not seep into any openings or seams. Wipe off any cleanser residue with clean damp cloth.

i.C³® Touchscreen

To remove any dirt or fingerprints from the front surface of displays or touch screens, use an alcohol pad and a clean, lint-free cloth. All electronic areas must be completely dry and free of foreign material before returning the product to service.

Cabinet Interior

Clean painted surfaces with a damp cloth and mild detergent. Thoroughly dry all surfaces using a clean soft cloth.

Door Gasket

Clean with a soft cloth and mild soap and water solution. Thoroughly dry gasket using a clean soft cloth.

Bin Assembly

Note

Avoid contaminating supplies and medications stored in the product when cleaning bins.

Remove bin from compartment and clean bin and bin cover with soft cloth and mild soap and water solution. Thoroughly dry all surfaces using clean soft cloth before reinstalling.

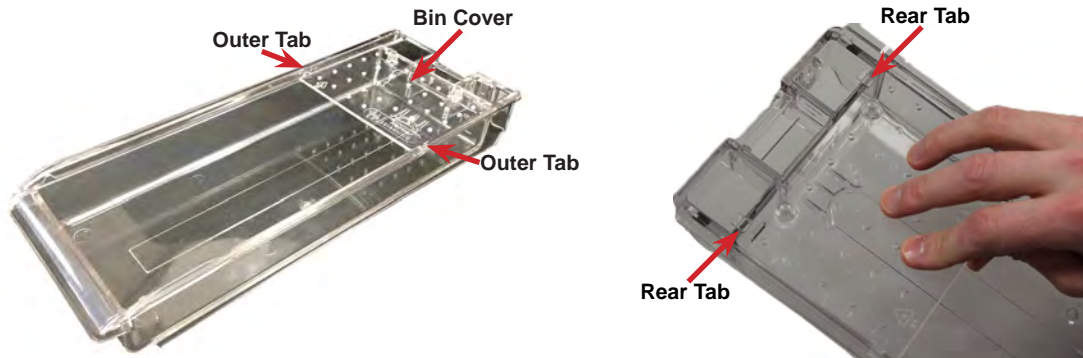

Remove Bin and Cover

1. Use the two override keys to remove the override cover.
2. Pull on the manual release red tab to unlock the bins.
3. Slide the bin out until it stops.
4. Using your hands, gently expand the top edge of the bin outward.
5. While holding the top edge of the bin outward, press the front edge of the bin cover upward. The tabs on the outer edges of the bin cover will disengage from the corresponding slots on the top edges of the bin. The front of the bin cover will lift from the bin.
6. Lift the bin cover upward and remove cover from the bin.
7. Lift the bin upward and pull the bin out of the compartment location.

Install Bin and Cover

1. Slide the bin partially into the compartment until the curved groove on the bottom of the bin crosses the bin stop.
2. Allow the bin to rest on the bottom of the compartment against the stop.
3. Insert the bin cover into the compartment, on top of the bin.
4. The three posts on the bin cover must be pointing upward.
5. The tabs on the rear of the bin cover should link with the corresponding slots at the back of the bin.
6. Lower the front edge of the bin cover.
7. Using your hands, gently expand the top edge of the bin outward.
8. While holding the top edge of the bin outward, alternately press each front edge of the bin cover downward. The tabs on the outer edges of the cover will link with the corresponding slots on the top edges of the bin.
9. Push the bin completely into the compartment until it locks.
10. Disengage the red tabbed manual release and verify bins are closed and locked.
11. Reinstall the override cover and lock with both keys.

Condenser Grill



NOTICE

Disconnect refrigerator from AC power when cleaning.

Note

In environments where the BD Pyxis™ ES refrigerator is exposed to excessive lint or dust, condenser grill may require cleaning more frequently than stated in preventive maintenance schedule.

To access the condenser grill, remove the front panel below the door. Clean the condenser grill using a soft brush and a vacuum cleaner.

5 Service

5.1 Refrigerant



Risk of fire or explosion. Flammable refrigerant used. To be repaired only by trained service personnel. DO NOT puncture refrigerant tubing.

NOTICE

- Review all safety instructions prior to recharging refrigerant.
- Maintenance should only be performed by trained refrigeration technicians familiar with hydrocarbon refrigerants.

Table 5. Refrigerant Charge

| Refrigerant | Initial Charge |
|-------------|--------------------|
| R600A | 2.5 oz (70g +/-1g) |

5.2 CSV Download

A CSV download captures historical data from the refrigerator and allows it to be placed on a removable storage device. The amount and type of data downloaded will vary depending on whether a **User** or **Tech** (Technician) data set is selected.

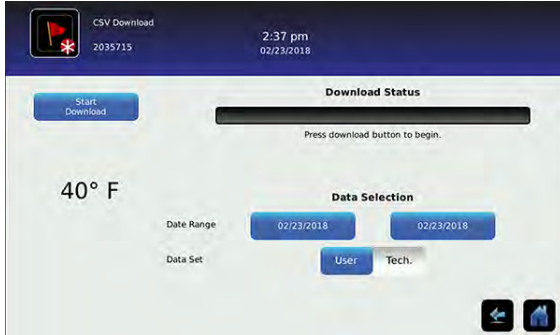

Table 6. CSV File Generation Content

| CSV Data Generated | Data Set | |
|-----------------------|----------|------------|
| | User | Technician |
| Primary Monitor Probe | ✓ | ✓ |
| Compressor Probe | | ✓ |
| Control Probe | | ✓ |
| Mains Voltage | | ✓ |
| Access Control DB | | ✓ |
| Access Log DB | ✓ | ✓ |
| Defrost | | ✓ |
| Door Opening DB | | ✓ |
| Drive Space | | ✓ |
| Events DB | ✓ | ✓ |
| VCC Actual Speed | | ✓ |
| VCC Speed Setting | | ✓ |

Notes

- The USB Port must be enabled prior to performing a CSV download.
- Downloads can only be performed when the refrigerator is not connected and communicating with the MedStation.
- Dates which are grayed out on the calendar do not contain recorded data and cannot be individually selected.

Downloading CSV File

1. From the Home screen, select the Settings Button. The Settings screen appears.
2. Select the Auxiliary Systems Button and turn on the USB Port. Select the back arrow to take you back to the Settings screen.
3. Select CSV Download. The CSV Download screen appears.
4. Insert a USB flash drive in the USB drive located in the side of the i.C³ bezel.
5. Touch the beginning Date Range button (left). A calendar will appear.
6. Use the arrow buttons at the top or bottom of the calendar to select the beginning month, then select the date and press the green check mark to confirm.
7. Touch the ending Date Range button (right). A calendar will appear.
8. Use the arrow buttons at the top or bottom of the calendar to select the beginning month, then select the date and press the green check mark to confirm.
9. Select User or Tech data set.
10. Touch Start Download. The Download Status bar will show the progression of the download. DO NOT remove flash drive while download is in progress.
11. Once the download is complete, the **Data download complete** message will appear, and the flashdrive can be removed.

6 Troubleshooting

NOTICE

Review all safety instructions prior to troubleshooting.

6.1 Access System Problems

| Problem | Possible Cause | Action |
|---------------------|--|---|
| Door does not lock. | Door lock key switch is in the off "o" position. | Turn the key to the on "-" position. |
| | Magnetic door lock is not aligned to the strike plate. | Align lock/door to the match strike plate. |
| | Magnetic lock is not receiving power. | Ensure MedStation is not unlocking the door (refrigerator display will show the unlocked icon). Trace voltage to the lock using the schematic, replace lock if needed. |
| Door does not open. | Signal from MedStation was not sent. | Unlock the door from the MedStation. |
| | Signal from MedStation was not received. | Check Ethernet connections and try again. |
| Bin will not lock. | Bin is not pushed back to lock position. | Check for obstruction, push bin back in place. |
| | Latch is broken. | Replace bin module. |
| | Solenoid is engaged. | Check for obstruction behind solenoid. |
| | Module manual release lever is engaged | Disengage module manual release lever. |
| Bin will not open | Signal from MedStation was not sent. | Unlock bin from the MedStation. |
| | Signal from MedStation was not received. | Check Ethernet connections and try again. |
| | Solenoid is not activated. | Trace voltage from the solenoid using the schematic. |
| | System on battery power | Solenoids will not activate when on battery power. |

6.2 Chamber Temperature Problems

| Problem | Possible Cause | Action |
|--|--|---|
| Temperature display does not match actual temperature. | Display temperature needs to be calibrated. | Follow temperature calibration process. |
| Chamber temperature is too high/low. | Display temperature needs to be calibrated. | Follow temperature calibration process. |
| | Door was recently opened or opened for an extended time. | Close door and allow temperature to stabilize. |
| | Condenser coil is dirty. | Clean the condenser coil regularly, removing all dust build up. |
| | Lack of air flow around unit/ high ambient condition. | Check for proper packing around unit, any foreign objects blocking airflow, and that ambient temperature is within specification. |
| | Temperature setpoint was adjusted. | Check temperature setpoint and temperature settings. Change to default settings or desired setpoint. |
| | Control probe is reading too high/low. | Check control offset setting, adjust if needed. |
| | Unit cooler fan motor (inside chamber) is not running. | Check voltage to the fan motor using schematic, replace fan motor if needed. |
| | Condenser fan motor (exterior) is not running. | Check voltage to the fan motor using schematic, replace fan motor if needed. |
| | Compressor is not running. | Check voltage to the compressor using schematic, replace compressor start components if needed. |

6.3 Alarm Problems

| Problem | Possible Cause | Action |
|---|--|---|
| Battery alarms. | The battery key switch is in the off "o" position. | Turn the key to the on "-" position. |
| | The battery is low due to a power failure. | Allow battery to recharge. |
| | Faulty battery or wiring connection. | Check wiring and replace battery if needed. |
| Probe failure alarms. | Faulty probe or wiring connection. | Check corresponding probe connection. Test resistance of probe (86Ω to 110Ω). Replace probe if needed. |
| Power failure alarm. | Power was interrupted to refrigerator. | Restore facility power. |
| | Power switch is in the off "o" position. | Turn power switch to the on "-" position. |
| | Power cord is loose. | Check both ends of the power cord at the wall outlet and the refrigerator. |
| Door alarm. | Door is open. | Close door. |
| | Door alarm delay is set to 0 minutes. | Check door alarm delay (3 minute default setting). |
| | Faulty door switch or wiring connection. | Check wiring and continuity of switch contacts. Replace switch if needed. |
| Communication alarms | Communication between circuit boards is lost. | Reboot/power cycle the refrigerator. Turn off both main power and battery power, then turn power back on. |
| Alarm is active, but there is no audible alarm. | Audible alarm setting is turned off (the default setting is off). | Turn the audible alarm setting on. |
| Compressor High Temperature Alarms | Condenser fan not operating. | Check voltage to fan motor using schematics. Replace fan if needed. |
| | Ambient location too warm or facility heating vent blowing into unit intake. | Relocate unit. |

6.4 Condensation Problems

| Problem | Possible Cause | Action |
|--|--|--|
| Excess condensation/ moisture inside chamber. | Foreign liquid spilled within chamber. | Verify liquid products are sealed, wipe up spilled liquid if necessary. |
| | Unit cooler condensation pan is not draining. | Check level of refrigerator and unit cooler drain pan, level if needed for proper gravity fed drainage. Check drain line for debris and clean if needed. |
| | Door was left open for an extended time. | Close door and allow chamber to stabilize. |
| | Chamber is not sealed. | Inspect door seal for damage, replace if needed. Check for wires routed through the door seal, reroute wires to the available through hole if needed. Check through holes and ensure they are sealed with putty, reseal if needed. |
| Condensate tray is overflowing. | High frequency of door openings or extended door open time in high humidity environment. | Close door and allow chamber to stabilize. (System may need to be shut down, AC power removed and tray emptied.) |
| | Chamber is not sealed. | Inspect door seal for damage, replace if needed. Check for wires routed through the door seal, reroute wires to the available through hole if needed. Check through holes and ensure they are sealed with putty, reseal if needed. (System may need to be shut down, AC power removed and tray emptied.) |

7 Parts

Notes

- Before replacing parts, protect items in refrigerator from extended exposure to adverse temperature.
- Allow refrigerator temperature to stabilize at setpoint after replacing parts or after extended door opening.
- Circuit boards are sensitive to static electricity and can be damaged by electrostatic discharge. Use proper ESD precautions when handling the display assembly.

NOTICE

Disconnect refrigerator from power when replacing LED lamps.

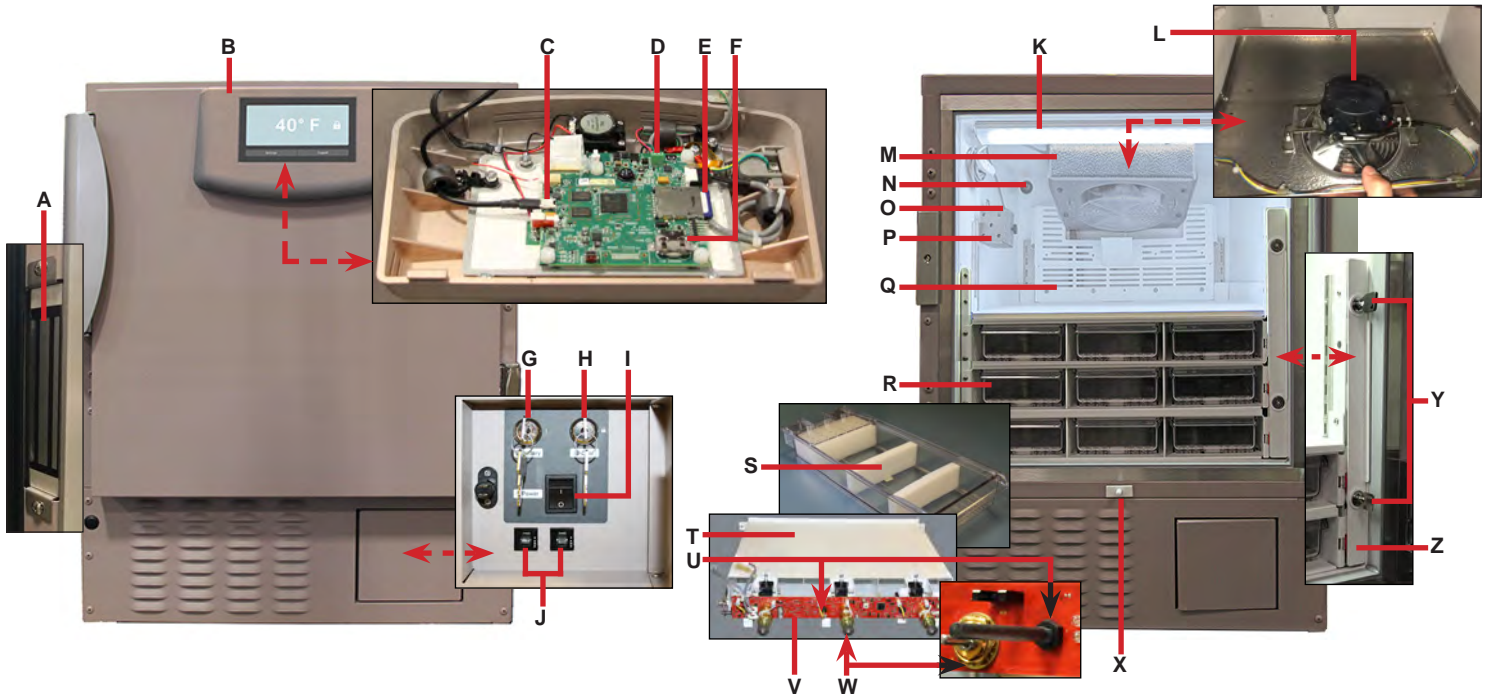

| Letter | Description | Volts | Part Number | Letter | Description | Part Number |
|--------|---|-------|-------------|-----------|-------------------------------|-------------|
| A | Magnetic lock (right) | | 801009-1 | O | Primary monitor probe | 800987-1 |
| | Magnetic lock (left) | | 801010-1 | P | Solid ballast | - |
| B | Bezel | 115 | 800989-1 | Q | Plenum | - |
| | | 230 | 801066-1 | R | Standard Bin | 800990-1 |
| C | Display Communication cable | | 800988-1 | Not shown | Deep Bin | 800994-1 |
| D | Display Power cable | | 800988-1 | S | Standard bin foam inserts | 801005-1 |
| E | SD card | | 800985-1 | Not shown | Deep bin foam inserts | 801006-1 |
| F | Display battery (CR2032) | | - | T | Standard module | 800986-1 |
| G | Battery key switch for monitor and lock | | - | Not shown | Deep module | 800993-1 |
| H | Door key switch | | - | U | Proximity sensor (quantity 3) | 800258-1 |
| I | Main power switch | | 120478 | V | IRACS board (PCB) | 801007-1 |
| J | Circuit breakers | | - | W | Solenoid (quantity 3) | 800261-1 |
| K | LED light strip | | 800023-1 | X | Door switch | 120380 |
| L | Unit cooler fan motor | | 800995-1 | Y | Bin lock override keys | - |
| M | Unit cooler | | 800982-1 | Z | Bin lock override cover | - |
| N | Probe access port | | - | Not shown | Door gasket | 321200-1 |



Risk of fire or explosion. Flammable refrigerant used. To be repaired only by trained service personnel. DO NOT puncture refrigerant tubing.

NOTICE

Disconnect the refrigerator from AC power before opening the electrical compartment.

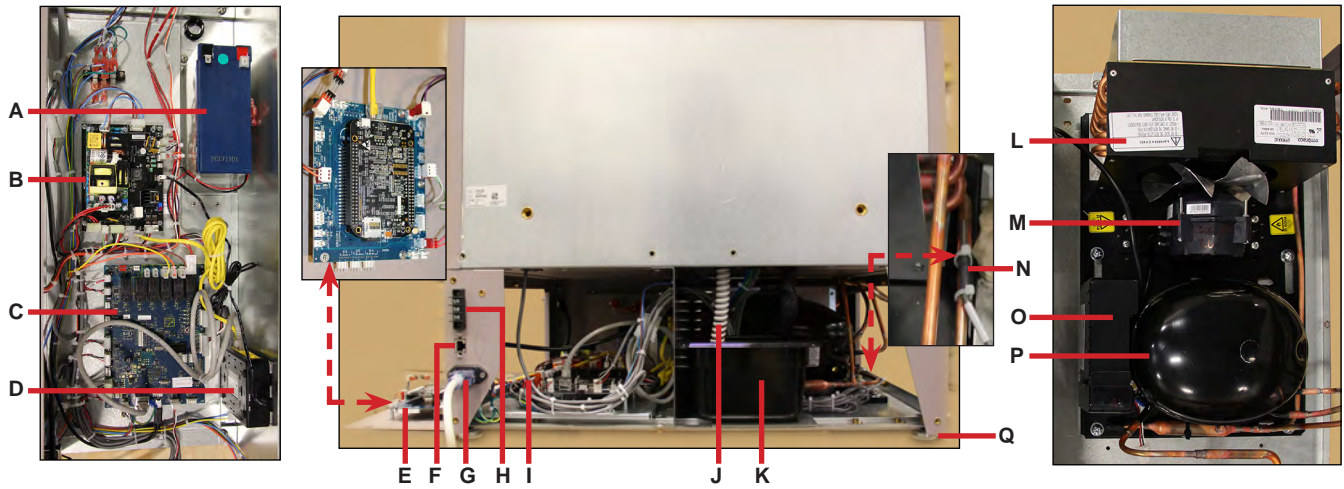

| Letter | Description | Volts | Part Number | Letter | Description | Volts | Part Number |
|--------|--|-------|-------------|-----------|----------------------------------|-------|-------------|
| A | Monitoring and control system backup battery | | 800999-1 | J | Drain tube | - | - |
| B | Power supply board | | 800984-1 | K | Condensate evaporator tray | - | - |
| C | i.C ³ control board | 115 | 800034-4 | Not Shown | Condensate heater assembly | 115 | 801144-1 |
| | | 230 | 801065-1 | | | 230 | 401901-2 |
| D | Router | 115 | 801011-1 | L | Condenser | - | - |
| | | 230 | 801068-1 | M | Condenser fan motor | - | 800996-1 |
| E | BBB/CAI | | 801019-1 | N | Condenser probe | - | 800039-1 |
| F | External WAN Ethernet port | | 120644 | O | Compressor controller (Inverter) | 115 | 800997-1 |
| G | Power cable | 115 | 120630 | | | 230 | 800998-1 |
| | | 230 | - | P | Compressor | - | 800991-1 |
| H | Remote alarm contact | | - | Q | Leveling feet | - | 800304-1 |
| I | IRACS module(s) control cable | | - | | | | |
| | | | | | | | |

8 Schematics

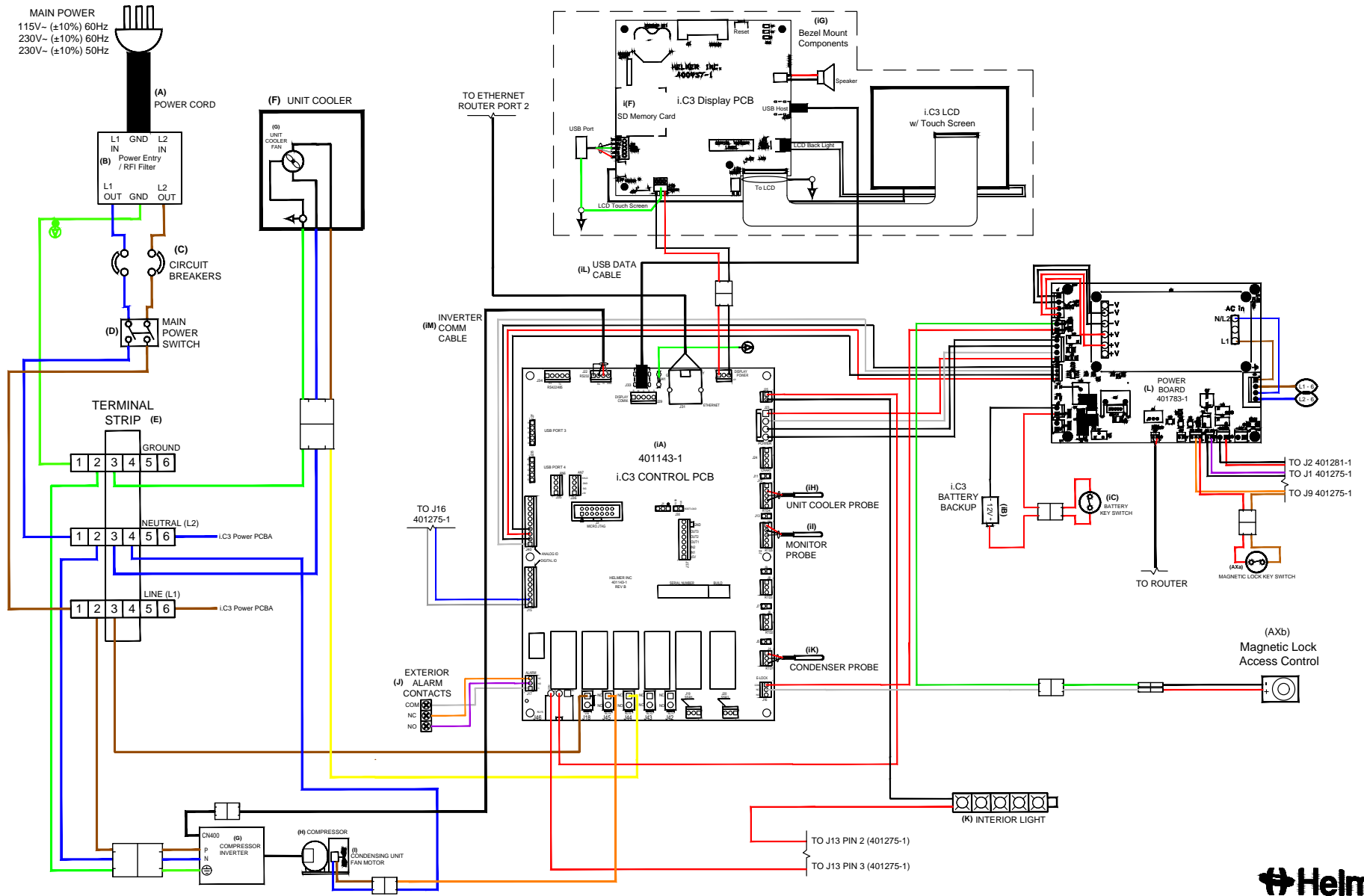

THESE DRAWINGS AND SPECIFICATIONS ARE THE SOLE PROPERTY OF HELMER INC. AND SHALL NOT BE REPRODUCED OR USED AS THE BASIS FOR MANUFACTURE OR SALES OF APPARATUS WITHOUT THE APPROVAL OF HELMER INC.

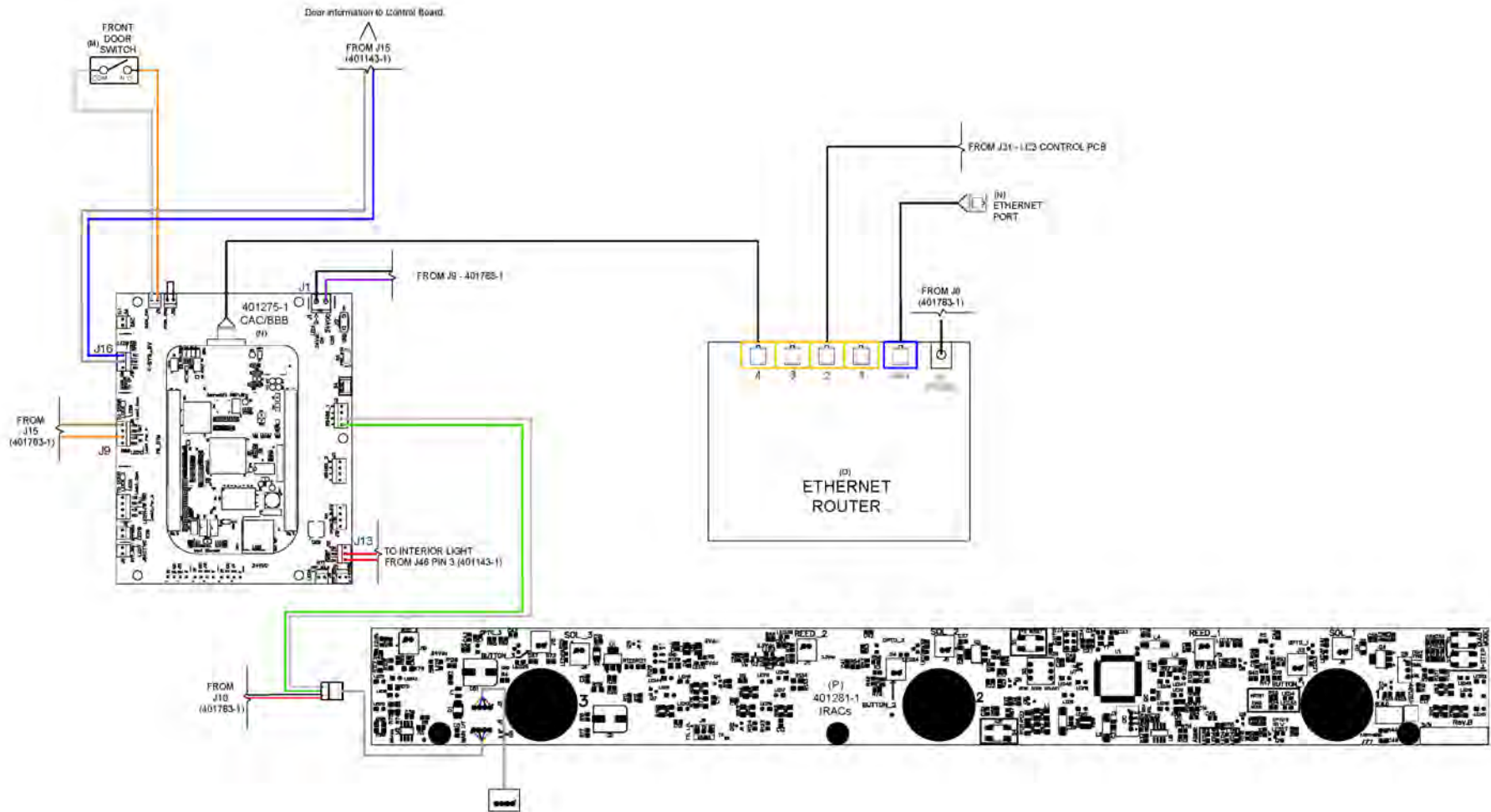

09S047

THESE DRAWINGS AND SPECIFICATIONS ARE THE SOLE PROPERTY OF HELMER INC. AND SHALL NOT BE REPRODUCED OR USED AS THE BASIS FOR MANUFACTURE OR SALES OF APPARATUS WITHOUT THE APPROVAL OF HELMER INC.

9 Compliance

9.1 Regulatory Compliance

 This device complies with the requirements of the following directives: 2011/65/EU (Restriction of Hazardous Substances), 2014/30/EU (Electromagnetic Compatibility (EMC) Directive), and 2014/35/EU (Low Voltage Directive).

This product is certified to applicable UL and CAN/CSA standards by a NRTL.

This device complies with FCC Radiated and Conducted Emissions Approval to CFR47, Part 15; Class A levels.



9.2 EMC Compliance

Helmer Scientific Refrigerators meet the applicable requirements of IEC61326 and EN55011 and are intended for use in the electromagnetic environment specified in 6.1 Operating Specifications. The customer or the user of these devices should assure they are used in such environment.

9.3 Manufacturer of Record

Helmer Scientific
14400 Bergen Blvd.
Noblesville, Indiana 46060

Helmer Scientific
14400 Bergen Boulevard, Noblesville, IN 46060 USA

Becton Dickinson and Company
Franklin Lakes, NJ United States | 201.847.6800 | BD.com