

Ultra-Low Freezer Service and Maintenance Manual

i.Series®

iUF118-GX
iUF126-GX



Document History

Revision	Date	CO	Supersession	Revision Description
A	16 FEB 2024*	26976	n/a	Initial release.

* Date submitted for Change Order review. Actual release date may vary.

Document Updates

The document is furnished for information use only, is subject to change without notice and should not be construed as a commitment by Helmer Scientific. Helmer Scientific assumes no responsibility or liability for any errors or inaccuracies that may appear in the informational content contained in this material. For the purpose of clarity, Helmer Scientific considers only the most recent revision of this document to be valid.

Notices and Disclaimers

Confidential / Proprietary Notices

Use of any portion(s) of this document to copy, translate, disassemble or decompile, or create or attempt to create by reverse engineering or otherwise the information from Helmer Scientific products is expressly prohibited.

Copyright and Trademark

Copyright © 2024 Helmer, Inc. Helmer®, i.Series®, i.C³®, Horizon Series™, and Rel.i™ are registered trademarks or trademarks of Helmer, Inc. in the United States of America. All other trademarks and registered trademarks are the property of their respective owners. Helmer, Inc., doing business as (DBA) Helmer Scientific and Helmer.

Disclaimer

This manual is intended as a guide to provide the operator with necessary instructions on the proper use and maintenance of certain Helmer Scientific products.

Any failure to follow the instructions as described could result in impaired product function, injury to the operator or others, or void applicable product warranties. Helmer Scientific accepts no responsibility for liability resulting from improper use or maintenance of its products.

The screenshots and component images appearing in this guide are provided for illustrative purposes only, and may vary slightly from the actual software screens and/or product components.

Contents

- 1 About this Manual 3**
 - 1.1 Intended Audience 3
 - 1.2 Model Reference 3
 - 1.3 Intended Use 3
 - 1.4 Safety Precautions and Symbols 3
 - 1.5 Avoiding Injury 4
 - 1.6 Model and Input Power 4
 - 1.7 Product Labels 4
- 2 Installation and Configuration 5**
 - 2.1 Location Requirements 5
 - 2.3 Placement and Leveling 5
 - 2.4 Connect Back-up Power 5
 - 2.5 Prepare for Monitoring 6
 - 2.6 External Monitoring Devices 8
 - 2.7 Back-up Refrigeration Systems (optional) 9
 - 2.8 Back-up System Contacts 9
 - 2.8 Configure Storage 10
- 3 Controls 11**
 - 3.1 Home Screen and Screensaver 11
 - 3.2 Home Screen Functions 11
 - 3.3 Alarm Conditions 12
 - 3.4 Settings 13
 - 3.5 Sensor Calibration 16
- 4 Maintenance 20**
 - 4.1 Alarm Tests 21
 - 4.2 Upgrade System Firmware 23
 - 4.3 Test and Replace Back-up Battery 23
 - 4.4 Defrost Ultra-Low Freezer 24
 - 4.5 Clean Ultra-Low Freezer 26
- 5 Service 27**
 - 5.1 Refrigerant 27
 - 5.2 Chamber Temperature Sensor Error Recovery 27
 - 5.3 Access Control Solenoid 30
 - 5.4 Exterior Door 30
 - 5.6 Casters 31
- 6 Troubleshooting 32**
 - 6.1 General Operation Problems 32
 - 6.2 Chamber Temperature Problems 33
 - 6.3 Alarm Activation Problems 35
 - 6.4 Icing Problems 36
- 7 Parts 37**
 - 7.1 Exterior Front and Door 37
 - 7.2 Interior Cabinet 38
 - 7.3 Electrical Panel 39
 - 7.4 Refrigeration Components and Exterior Rear 40
- 8 Schematics 41**
 - 8.1 Electrical Schematic 41
 - 8.2 Refrigeration Schematic (serial # 2134248 and prior) 42
 - Refrigeration Schematic (serial # 2134249 and higher) 43
- Appendix A: Warranty 44**

1 About this Manual

1.1 Intended Audience

This manual provides information on how to use the i.Series® Ultra-Low Freezer. It is intended for use by end users of the freezer and authorized service technicians.

1.2 Model Reference

Models are indicated by a distinguishing model number that corresponds to the series, type, number of doors and capacity of the freezer. For example, “iUF126-GX” refers to an i.Series Ultra-Low Freezer with 1 door and a capacity of 26 cu ft. This manual covers all ultra-low freezers, which may be identified singly, or by their size.

1.3 Intended Use

Helmer ultra-low freezers are intended to provide a controlled temperature environment at ultra-low temperatures required for the storage of biological materials, pharmaceuticals, and reagents used in a research or clinical laboratory. Helmer ultra-low freezers are FDA Class 2 medical devices and suitable for storage of blood, plasma, and tissue for re-introduction into the body.

The devices referenced in this manual are intended to be operated by personnel who have procedures in place for meeting FDA, AABB, or any other applicable regulations for the processing and storage of biological materials, pharmaceuticals, and reagents.

This unit is intended for use in laboratories in commercial, industrial, or institutional occupancies as defined in the Safety Standard for Refrigeration Systems, ASHRAE 15.

 **Note**

This equipment has been tested and found to comply with the limits for a Class A digital device, pursuant to part 15 of the FCC Rules. These limits are designed to provide reasonable protection against harmful interference when the equipment is operated in a commercial environment. This equipment generates, uses and can radiate radio frequency energy and, if not installed and used in accordance with the instruction manual, may cause harmful interference to radio communications. Operation of this equipment in a residential area is likely to cause harmful interference in which case the user will be required to correct the interference at his own expense.

1.4 Safety Precautions and Symbols

Symbols found in this document

The following symbols are used in this manual to emphasize certain details for the user:



Task Indicates procedures which need to be followed.



Note Provides useful information regarding a procedure or operating technique when using Helmer Scientific products.

NOTICE Advises the user against initiating an action or creating a situation which could result in damage to equipment; personal injury is unlikely.

Symbols found on the units

The following symbols may be found on the freezer or freezer packaging.



Caution: Risk of damage to equipment or danger to operator



Warning: Flammable material



Caution: Shock / electrical hazard



Warning: Crushing of hands / fingers



Caution: Hot surface



Refer to documentation



Warning: Low temperature / freezing conditions, frostbite



Earth / ground terminal

1.5 Avoiding Injury



- Do not use mechanical devices or other means to accelerate the defrosting process, other than those recommended by the manufacturer.
- Do not damage the refrigerant circuit.

Review safety instructions before installing, using, or maintaining the equipment.

- ◆ Before moving unit, remove contents from the chamber.
- ◆ Before moving unit, ensure door is closed and latched, and casters are unlocked and free of debris.
- ◆ Before moving unit, disconnect the AC power cord and secure the cord.
- ◆ When moving unit, use assistance from a second person.
- ◆ Never physically restrict any moving component.
- ◆ Avoid removing electrical service panels and access panels unless so instructed.
- ◆ Use appropriate gloves when handling cold internal components and stored inventory.
- ◆ Keep hands away from pinch points when closing the door.
- ◆ Avoid sharp edges when working inside the electrical compartment and refrigeration compartment.
- ◆ Ensure products are stored at recommended temperatures determined by standards, literature, or good laboratory practices.
- ◆ Proceed with caution when adding and removing product from the freezer.
- ◆ Total freezer weight (including contents) is not to exceed 1400 lbs (635 kg).
- ◆ Use manufacturer supplied power cord only.
- ◆ Avoid risk of ignition by using only manufacturer supplied components and authorized personnel when servicing the unit.
- ◆ Using the equipment in a manner not specified by Helmer may impair the protection provided by the equipment.
- ◆ Ensure product is stored safely, in accordance with all applicable organizational, regulatory, and legal requirements.
- ◆ The freezer is not considered to be a storage cabinet for flammable or hazardous materials.

REQUIRED: Decontaminate parts prior to sending for service or repair. Contact Helmer or your distributor for decontamination instructions and a Return Authorization Number.

1.6 Model and Input Power

Model and Input Power

Model	Voltage	Frequency	Current Draw
118-GX	115V	60 Hz	8.9 A
	220-240V	50/60 Hz	4.7 A
126-GX	115V	60 Hz	8.9 A
	220-240V	50/60 Hz	4.7 A

1.7 Product Labels

This information appears on the product specification label, located on the rear of the freezer. The model also appears on a label located in the chamber on the upper side of the right wall.



Label	Description
A	Model (REF)
B	Serial number
C	Power requirements

Sample Product Specification label

(For illustration only: regulatory information and other content shown here may differ from that on the equipment label)

2 Installation and Configuration

2.1 Location Requirements

- ◆ Has a grounded outlet on a dedicated circuit meeting the electrical requirements listed on the product specification label.
- ◆ Is clear of direct sunlight, high temperature sources, and heating and air conditioning vents.
- ◆ Minimum 8" (203 mm) above, and minimum 4" (102 mm) behind.
- ◆ Minimum 5" (127 mm) left.
- ◆ Minimum 7" (178 mm) between units if placing units side by side.
- ◆ Meets limits specified for ambient temperature and relative humidity as stated in the Product Specifications section of this manual.

2.3 Placement and Leveling

NOTICE

- To prevent tipping, ensure door is closed and latched, and casters are unlocked and free of debris before moving freezer.
- The freezer is extremely heavy. Helmer recommends two people work together to move the freezer.
- To avoid damaging refrigerant tubing or risking refrigerant leak, use caution when moving or operating the unit.
- Helmer does not recommend operating this unit on a GFI/GFCI outlet.

1. Ensure all casters are unlocked and door is closed and latched.
2. Roll freezer into place and lock casters.
3. Adjust leveling feet as necessary to ensure freezer is level.

Level the Unit

1. Set a bubble level on top of freezer cabinet. Orient the level front-to-back.
2. Using a 9/16" open-end wrench, back the jam nut away from the weld nut.
3. Hand-thread the leveling legs downward until they make contact with the floor.
4. Using a 5/8" open-end wrench, adjust the legs to achieve a flat reading (front to back) from a bubble level.
5. Check the leveling legs and rear casters to ensure the freezer contacts the floor at four points. Adjust both leveling legs as necessary to achieve four contact points.
6. Hand-thread the jam nuts upward until they make contact with the weld nut.
7. Place a 5/8" open-end wrench on the leveling legs to prevent them from rotating while the jam nut is tightened. Using a 9/16" open-end wrench, snug the jam nuts against the weld nuts.

2.4 Connect Back-up Power

The monitoring system has a back-up battery system, enabling a period of continuous monitoring if power is lost.

Battery life varies by manufacturer as well as voltage level remaining. Providing full power is available and no battery-related alarms are active, back-up power for the monitoring system is available for approximately 20 hours (the Low Battery alarm will activate after approximately 18 hours of battery use).

Notes

- The monitoring system and chart recorder (if equipped) will start on battery power alone. If the freezer was previously not connected to AC power and the battery is switched on, the monitoring system and chart recorder will begin running on battery power.
- If AC power is lost, the monitoring system will automatically disable some features to prolong battery power. Data collection will continue until battery power is depleted.
- The back-up battery system does not operate the refrigeration system.
- Use only a back-up battery which meets manufacturer specifications.



Back-up battery (monitoring system / access control / optional chart recorder)

2.5 Prepare for Monitoring

The Ultra-Low freezer is equipped with a rechargeable 12 V lead acid sealed battery. The battery is located in the electrical compartment, on the bottom left of the freezer and is switched off for shipping. Switch the battery on to provide the monitoring system with back-up power in the event of AC power failure.

Temperature Sensor

The i.C³ monitoring and control system obtains temperature readings from the chamber temperature sensor. The sensor is located on the lower back wall of the chamber.



Chamber temperature sensor (located behind cover).

Additional Sensors

Additional temperature sensors may be installed through one of the ports on the rear wall of the cabinet. The ports are located in the top-left corner and bottom-left corner. The ports consist of two plastic caps - one inside the cabinet and one on the outside. The cabinet insulation fills the void between the plugs.

NOTICE

Do not drill holes in the cabinet. Drilling holes may damage the insulation in models equipped with vacuum-insulated panels, or may damage the evaporator coil causing a loss of refrigerant.

Notes

- Use a tool with a diameter only large enough to accommodate the sensor wiring.
- Helmer recommends installing additional sensors through the upper or lower rear ports provided.
- Installation of an optional third party probe should be completed prior to powering the unit on.
- The rear ports may also be used to install tubing for an optional (field-installed) CO₂ / LN₂ back-up refrigeration system.

Install Additional Sensor

1. Remove the plastic plugs on the outside and inside of the cabinet.
2. Use a screwdriver or similar tool to pierce the insulating foam.
3. If using the lower left port, insert the tool from the outside, through the foam, to the inside of the cabinet.
If using the upper port, insert the tool from inside the cabinet, through the foam, to the outside of the unit.
4. Secure the sensor inside the cabinet as necessary.
5. Seal the hole in the foam using Permagum putty or press-in cork tape, ensuring a tight seal.

Chart Recorder (optional)

If installed, refer to the Temperature Chart Recorder Operation and Service Manual.

The temperature chart recorder has a back-up battery system, enabling a period of continuous operation if power is lost. Battery life varies by manufacturer as well as voltage level remaining. Providing full power is available, back-up power for the chart recorder is available for up to 20 hours.

Prior to use:

Calibrate chart recorder to match chamber temperature

Setup and Operation

Access chart recorder by pressing and releasing the door.

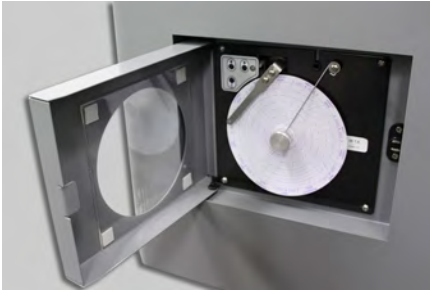

Install / Replace Chart Paper

Notes

- For accurate temperature reading, ensure the current time is aligned with the time line groove when chart knob is tightened
- Contact Helmer Customer Service to reorder chart paper; part number 800197-1 (52 sheets).



Chart recorder stylus and time line groove

1. Press and hold **C** button. When stylus begins to move left, release button. The LED flashes to indicate current temperature range.
2. When stylus stops moving, remove chart knob then move knob up and away.
3. Place chart paper on chart recorder.
4. Gently lift stylus and rotate paper so current time line corresponds to time line groove.
5. Hold chart paper and reinstall chart knob is fully tightened. (*Failure to fully tighten the knob can result in paper slipping and losing time.*)
6. Press and hold **C** button. When stylus begins to move right, release button.
7. Confirm stylus is marking on paper and stops at the correct temperature.
8. Calibrate chart recorder to match primary temperature if needed and close recorder door.

2.6 External Monitoring Devices

The remote alarm interface is a relay switch with three terminals:

- ◆ Common (COM)
- ◆ Normally Open (NO)
- ◆ Normally Closed (NC)

Terminals are dry contacts and do not supply voltage. Interface circuit is either normally open or normally closed, depending on terminals used.

Requirements for your alarm system determine which alarm wires must connect to terminals.



- The interface on the remote alarm monitoring system is intended for connection to the end user's central alarm system(s) that uses normally-open or normally-closed dry contacts.
- If an external power supply exceeding 30 V (RMS) or 60 V (DC) is connected to the remote alarm monitoring system's circuit, the remote alarm will not function properly; may be damaged; or may result in injury to the user.

The terminals on the remote alarm interface have the following maximum load capacity:

- ◆ 0.5 A at 30 V (RMS)
- ◆ 1.0 A at 60 V (DC)



Connect to Remote Alarm Interface

1. Switch battery ON/OFF switch **OFF**. Switch AC ON/OFF switch **OFF**.
2. On the back of the freezer, locate the remote alarm terminals.
3. Connect remote alarm wires to appropriate terminals, according to requirements for your alarm system.
4. Use a cable tie to relieve strain on alarm wires (as necessary).
5. Switch AC ON/OFF switch **ON**. Switch battery ON/OFF switch **ON**.
6. Touch **Mute or raise the high alarm limit** to disable the high temperature alarm while freezer reaches operating temperature. (If high alarm limit is changed, it must be changed back prior to operation of freezer.)

2.7 Back-up Refrigeration Systems (optional)

A back-up refrigeration system may be installed to ensure the chamber temperature remains below a critical level in the event of an extended power failure or an equipment failure. If the chamber temperature rises to a pre-determined setpoint, the back-up refrigeration system will inject carbon dioxide (CO₂) or liquid nitrogen (LN₂) into the chamber to keep the chamber temperature within a specified range.

NOTICE

- The temperature setpoint for the CO₂ / LN₂ injection should be set to a value within the freezer operating range (-50 °C to -86 °C).
- Do not drill holes in the cabinet. Drilling holes may damage the insulation in models equipped with vacuum-insulated panels, or may damage the evaporator coil, causing a loss of refrigerant.

Install Optional Back-up Refrigeration System

Follow the back-up refrigeration system manufacturer's directions to install the back-up system.

Notes

- Installation of an optional back-up refrigeration system should be completed prior to powering the unit on.
- Helmer recommends installing the back-up refrigeration system door switch along the handle-side of the door. This will prevent the door switch from interfering with the vacuum port, located near the top of the door.
- External sensors for the back-up refrigeration system may be installed through ports in the side or rear of the freezer cabinet.
- Three threaded screw holes have been provided on the interior back wall of the cabinet to assist in installing and routing the back-up refrigeration system. Holes are #8-32 thread, with Phillips screws temporarily installed.
- Back-up CO₂ and LN₂ Refrigeration Systems are available from Helmer Scientific.



Threaded screw holes and distribution port for back-up refrigeration system installation

2.8 Back-up System Contacts

Remote contacts are provided on the back of the freezer for the back-up refrigeration system. The back-up system may be connected to the i.C³ monitoring and control system with the remote contacts. If the back-up system is activated, the system activation will be communicated to the i.C³ through the remote contacts. An icon will be displayed on the i.C³ to indicate that the back-up system has been activated.

NOTICE

The i.C³ monitoring and control system does not control the operation of the back-up refrigeration system.

2.8 Configure Storage



Use appropriate gloves when handling cold interior components and stored inventory.

NOTICE

- Keep hands away from pinch points when closing the door.
- Before moving shelves, ensure they are empty for safe lifting.
- Maximum shelf load is not to exceed 160 lbs (73 kg).
- Total freezer weight (including contents) is not to exceed 1400 lbs (635 kg).
- Before moving storage components, protect stored items in freezer from extended exposure to adverse temperature.
- Helmer recommends moving storage racks before the unit reaches the setpoint temperature.
- When removing or replacing storage racks, do not allow the storage rack to set on the top edge of a partially-open interior door.
- To avoid damage to the interior door hinges, do not apply upward or downward force to the interior doors.

Product Loading Guidelines

When loading your freezer, take care to observe the following guidelines:

- ◆ Never load freezer beyond capacity.
- ◆ Always store items within shelves.

Shelves

Remove Shelf

1. Using both hands, lift the front edge of the shelf off the shelf clips.
2. While holding the shelf at an angle, lift and remove it from the chamber and set aside.

Install Shelf

1. Insert shelf into chamber holding it at an angle.
2. Lower the back edge of the shelf onto the shelf clips in the rear of the unit.
3. Pivot the shelf downward, lowering the front edge onto the shelf clips.

Move Shelf Clips

1. Grip the shelf clip and pivot it upward to disengage the lower tab from the standard.
2. Disengage the upper tab from the standard and remove the clip.
3. Insert the upper tab into a slot in the standard at the desired location.
4. Pivot the shelf clip downward and insert the lower tab into the corresponding slot on the standard.
5. Repeat for each shelf clip until all four clips are at the same level.



Shelves



Shelf clip and shelf standard

3 Controls

i.Series® Ultra-Low freezers are equipped with the i.C³ monitoring and control system. The i.C³ system combines temperature monitoring and control into a single user interface.

3.1 Home Screen and Screensaver

The Home Screen is the default screen and is displayed when:

- ◆ The Home icon is touched from any other screen.
- ◆ There is no interaction for two minutes on most screens other than those used to enter a password.



Home Screen

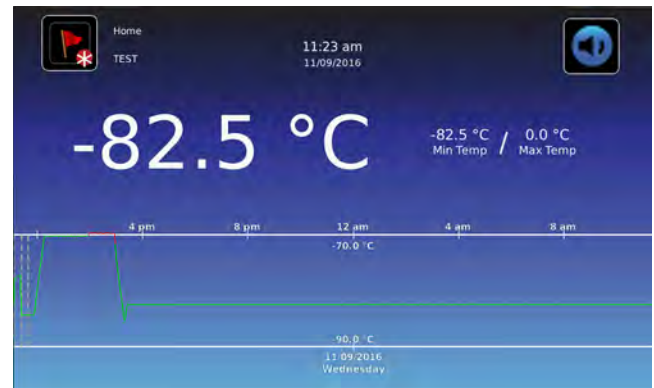

Temperature Graph Screensaver

3.2 Home Screen Functions

Note

Refer to the i.C³ User Guide for options available on all i.C³ screens.

- ◆ View current interior cabinet temperature readings
- ◆ View min/max temperature occurrence for a specified time period
- ◆ View the current system time and date
- ◆ Access any of the five homescreen applications (touch **i.C³ APPS** for additional applications)
- ◆ View information about current alarm events
- ◆ View whether the monitoring system is running on battery power
- ◆ Mute audible alarms
- ◆ View a graph of the chamber temperature
- ◆ View unit ID

3.3 Alarm Conditions

If an alarm condition is met, an alarm activates. Some alarms are visual only; others are visual and audible. Some alarms are sent through the remote alarm interface. The table indicates if an alarm is audible (A), visual (V), or sent through the remote alarm interface (R).

 **Note**

The primary monitor probe was formerly referred to as the chamber temperature sensor.

Alarm Reference

Alarm	Alarm Type
High Temperature (Primary Monitor Probe)	A, V, R
Low Temperature (Primary Monitor Probe)	A, V, R
Sensor Failure: Chamber Temperature Control	A, V, R
High Ambient Temperature	V, R
Low Ambient Temperature	V, R
Sensor Failure: Ambient Temperature	A, V, R
Refrigeration System: High Stage Compressor Temperature	A, V, R
Sensor Failure: High Stage Compressor Temperature	A, V, R
Sensor Failure: High Stage Condenser Temperature	A, V, R
Refrigeration System: High Stage Compressor Failure	A, V, R
Refrigeration System: High Refrigerant Pressure	A, V, R
Refrigeration System: Low Stage Compressor Temperature	A, V, R
Sensor Failure: Low Stage Compressor Temperature	A, V, R
Refrigeration System: Low Stage Compressor Failure	A, V, R
Sensor Failure: Heat Exchanger Temperature	A, V, R
Low Battery	V, R
No Battery	A, V, R
Power Failure: No AC	A, V, R
Power Failure: High Voltage	A, V, R
Power Failure: Low Voltage	A, V, R
Power Up	-
Door Open (Time)	A, V, R
Clean Filter	V, R
CO ₂ / LN ₂ Back-up System Active (Optional)	V, R
Communication Failure 1: Control Board	A, V, R
Communication Failure 2: Configuration File	A, V, R
Communication Failure 3: Database	A, V, R
Date / Time Change	-

3.4 Settings



Through the i.C³ monitoring and control system, current settings may be viewed and changed. To view settings, touch **i.C³ APPS, Settings**. Use a touch-drag motion to scroll up or down to display additional settings.

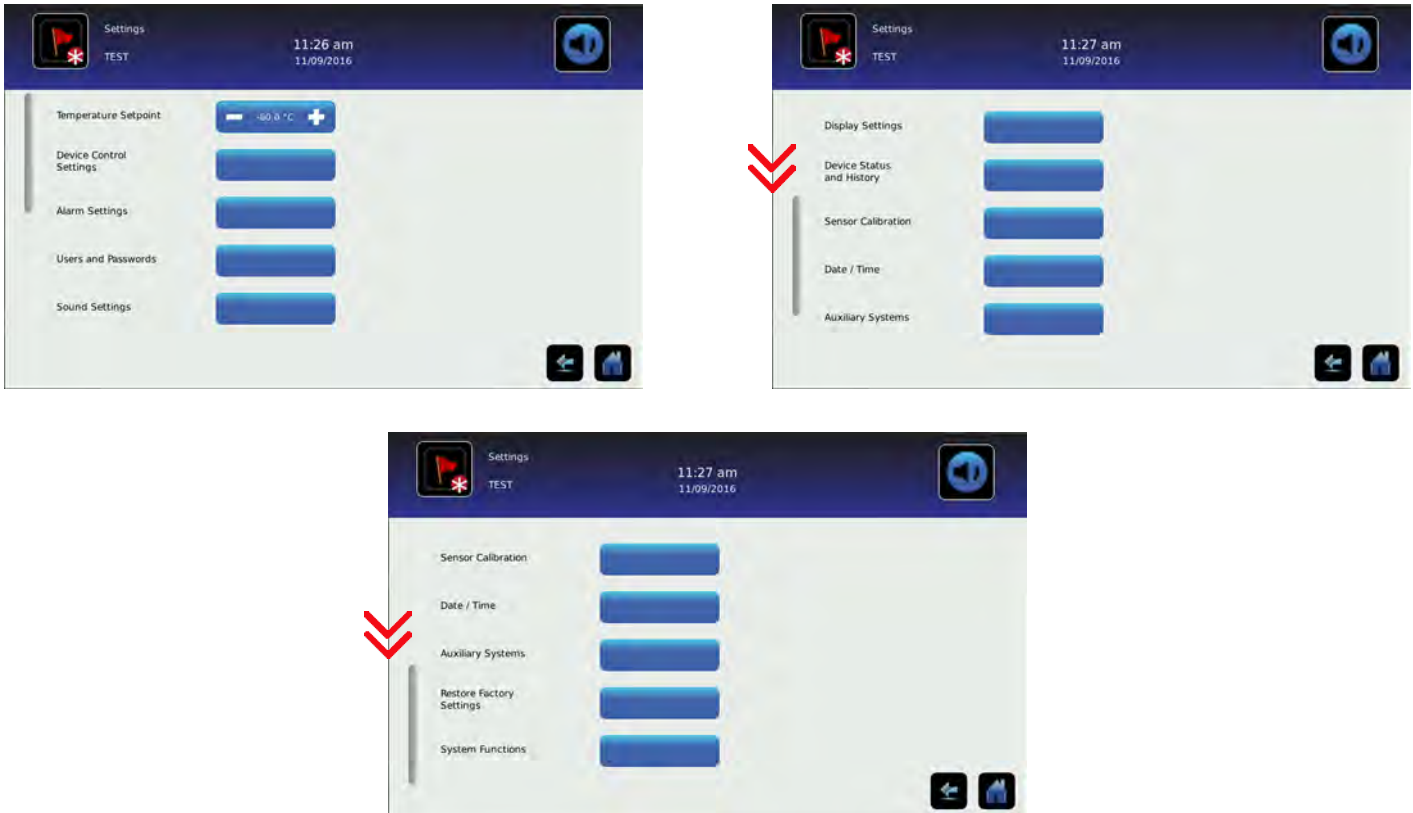

Settings screens

Note

- If the Settings screen is password protected enter appropriate password. If viewing settings for the first time, enter factory default password of "1234".
- Default chamber temperature setpoint is -80 °C. The lowest setpoint that can be set is -86 °C.
- Default values for general settings, alarm settings, and display settings are available in the i.C³ User Guide for Ultra-Low Freezers.
- Changing temperature settings affects the operation of the freezer. Do not change settings unless instructed in product documentation or by Helmer Technical Service.

The i.C³ temperature monitor and controller is programmed at the factory. To change a setting, first enter the Settings screen, then the setting. The method for accessing the Settings mode for each setting varies.

Device Control Settings

Device control settings are programmed at the factory. Setpoints can be viewed and changed through the i.C³ monitoring and control system. To view the temperature setpoint, touch **i.C³ APPS, Settings, Device Control Settings**.

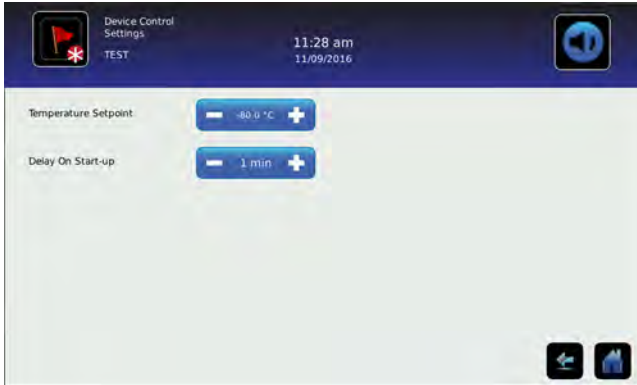

Device Control Settings screen

Setpoints

Setting	Initial Factory Value
Temperature Setpoint	-80.0 °C
Delay on Start-Up	1 minute

Temperature Setpoint

The setpoint is the temperature at which the unit operates.

Notes

- If the Settings screen is password protected enter appropriate password. If viewing for the first time, enter the factory default password of “1234”.
- Change the setpoint if your organization requires a chamber temperature other than -80.0 °C.
- Temperature Setpoint can be adjusted through the main Settings screen and Device Control Settings.

Change Temperature Setpoint

1. Touch **i.C³ APPS, Settings**.
2. Enter the Settings password.
3. Touch minus (–) or plus (+) on the **Temperature Setpoint** spin box.

Delay on Start-Up

Compressor start-up is delayed to allow the i.C³ monitoring and control system to start first.

User Configurable Alarm Settings

The following alarm settings may be changed by the operator. The setpoint for temperature alarms may be changed (where applicable), as well as the time delay between when the alarm condition commences and when the visual and audible alarms are initiated.

User Configurable Alarms

Setting	Description	Default Setpoint	Default Time Delay
High Temperature	High temperature at which alarm condition occurs	-70.0 °C	0 minutes
Low Temperature	Low temperature at which alarm condition occurs	-90.0 °C	0 minutes
Power Failure	Time after power failure occurs until alarm sounds	n/a	1 minute
Probe Failure	Time after probe failure occurs until alarm sounds	n/a	0 minutes
Door Open (Time)	Time door remains open until alarm sounds	n/a	1 minute
High Ambient	High temperature at which alarm condition occurs	30.0 °C	15 minutes
Low Ambient	Low temperature at which alarm condition occurs	15.0 °C	15 minutes



Alarm Settings screens

Change an Alarm Setting

1. Touch **i.C³ APPS, Settings**.
2. Enter the Settings password (default password is "1234").
3. Scroll down and touch **Alarm Settings**.
4. Touch the minus (-) or plus (+) on the corresponding **Setpoint** spin box to change an alarm setpoint.
5. Touch the minus (-) or plus (+) on the corresponding **Time Delay** spin box to change the time delay duration
6. Touch **Home** to exit the Alarm Settings screen.

Note

Changing a temperature alarm setting to a value within the operating range of the freezer may trigger a temperature alarm.

Non-Configurable Alarms

The following alarms indicate operational conditions which require the attention of the operator or a qualified service technician.

Note

The Clean Filter alarm can only be cleared by going to the Event Log Detail screen and acknowledging the event.

Non-Configurable Alarms

Alarm	Description
Compressor Temperature	Low stage or high stage compressor discharge temperature is too high
Condenser Temperature	High stage condenser discharge temperature is too high
Clean Filter	Air filter is dirty, clean or replace filter
CO ₂ / LN ₂ Active	CO ₂ / LN ₂ back-up refrigeration system has been activated
Low Battery	Rechargeable battery voltage is low
No Battery	Rechargeable battery voltage is too low or battery is disconnected
Refrigeration System	<ul style="list-style-type: none"> • Refrigerant pressure is too high • High stage compressor temperature is above the upper limit • Low stage compressor temperature is above the upper limit • High stage compressor has failed • Low stage compressor has failed
Emergency Mode	Chamber temperature sensor has failed, and i.C ³ system is operating high stage and low stage compressors at 100% duty cycle
Communication Failure	<p>Communication Failure 1</p> <ul style="list-style-type: none"> • Triggered if communication is lost between i.C³ display board and control board • Unit will continue to run with previously-saved settings • Screen will not display temperature changes or alarm conditions • i.C³ system will continue to reset until connection is re-established <p>Communication Failure 2</p> <ul style="list-style-type: none"> • Triggered if communication is lost between i.C³ display board and internal system memory • Unit will continue to run with previously-saved settings <p>Communication Failure 3</p> <ul style="list-style-type: none"> • Triggered if the database is corrupted • The database is archived and a new database is automatically created • Unit will continue to run with previously-saved settings

3.5 Sensor Calibration



Sensor calibration values are programmed at the factory. Calibration values can be viewed and changed through the i.C³ monitoring and control system. To view calibration settings, touch **i.C³ APPS**, **Settings** and scroll down to **Sensor Calibration**.



Sensor Calibration screens

NOTICE

Changing calibration settings affects operation of the freezer. Do not change settings unless instructed in product documentation or by Helmer Technical Service.

Notes

- If the Settings screen is password protected, enter the appropriate password. If viewing settings for the first time, enter factory default password of "1234".
- After one hour of no interaction, the Home screen or Temperature Graph screensaver (if enabled) is displayed.
- The Low Stage Compressor Discharge, Cascade Heat Exchanger, High Stage Compressor Discharge, and High Stage Condenser Discharge Offset settings are factory-preset and should not be changed unless directed by Helmer Technical Service.

Primary Monitor/Control Probe

Verify primary monitor/control probe is reading chamber temperature correctly by comparing probe reading on the Sensor Calibration screen to the temperature measured by calibrated reference thermometer. If the probe is not reading correctly, change the value displayed on the monitor.

NOTICE

Use appropriate gloves when handling cold interior components and stored inventory.

Notes

- The primary monitor probe was formerly referred to as the chamber temperature sensor.
- The primary monitor/control probe is factory-calibrated and should be verified on an annual basis. Calibrate when required or as dictated by facility standard operating procedures.
- The primary monitor/control probe is 100 Ω platinum RTD.
- Ensure the independent thermometer is not touching the cabinet wall or any other metallic components inside the cabinet.
- Calibration must be done with an independent thermometer that is calibrated and traceable per national standards.
- Initial factory calibration setting varies.
- Offset value can be changed from -10.0°C to +10.0°C.

Calibrate control/primary monitor probe

1. Move contents within the freezer to gain access to the probe located in the bottom compartment against the rear wall.
2. Using a zip-tie, attach the independent thermometer to the cover surrounding the probe.
3. Close the door and allow the chamber temperature to stabilize for a minimum of five minutes.
4. Observe and note the thermometer temperature.
 - ◆ If the temperature variance is within ± 1.0 °C of the temperature displayed, calibration is not necessary.
 - ◆ If the temperature variance is greater than ± 1.0 °C of the temperature displayed, calibrate the sensor.
5. Touch, **i.C³ APPS, Settings, Sensor Calibration**.
6. Touch minus (-) or plus (+) on the corresponding spin box to increase or decrease the value to match the measured value.
7. Remove thermometer from the sensor cover.
8. Replace freezer contents.

Ambient Temperature Probe

Verify ambient temperature sensor is reading ambient temperature correctly by comparing sensor reading to temperature read by an independent, calibrated and traceable thermometer. If sensor is not reading correctly, change the offset value displayed on the monitor.

NOTICE

Avoid sharp edges when working inside the refrigeration compartment.

Notes

- The ambient temperature probe is factory-calibrated and should be verified on an annual basis. Calibrate when required or as dictated by facility standard operating procedures.
- The ambient temperature probe is 100 Ω platinum RTD.
- Ensure the independent thermometer is not touching the condenser or any other metallic components in the area.

Calibrate ambient temperature probe

1. Remove the condenser grill to gain access to the sensor.
2. Using a zip-tie, attach the independent thermometer (with 5' (1524mm) lead or greater) to the same point as the sensor.
3. Allow the thermometer temperature to stabilize for a minimum of three minutes.
4. Observe and note the thermometer temperature.
 - ◆ If the temperature variance is within ± 1.0 °C of the temperature displayed, calibration is not necessary.
 - ◆ If the temperature variance is greater than ± 1.0 °C of the temperature displayed, calibrate the ambient sensor.
5. Touch, **i.C³ APPS, Settings, Sensor Calibration**.
6. Touch minus (-) or plus (+) on the **Ambient** offset spin box to increase or decrease the offset value until the displayed value matches the measured value.

Note

After saving the new temperature value, the displayed temperature may take several minutes to change to match the new value.

7. Remove thermometer from the sensor.
8. Replace the condenser grill.

Factory-Calibrated Sensors

The low stage compressor discharge sensor, cascade heat exchanger sensor, high stage compressor discharge sensor, and high stage condenser discharge sensor are factory-calibrated and do not require field calibration.

These sensors are difficult to reach to verify the accuracy of any calibrations.

Factory Default Settings

Settings listed below may be simultaneously returned to factory default values.



Note

The factory default settings may not be the same as the settings that were factory-calibrated before the freezer was shipped.

Restored Settings

Setting	Restored Value
Home Screen Application Icons	i.C ³ APPS, Settings, Temperature Graph, Information Logs, Download
Display Brightness	High (3 symbols)
Password (for Settings screen)	1234
Sounds	On
Alarm Volume	9
Alarm Tone	3
Temperature Calibration Values	Varies (calibrated at factory)
Low Stage Compressor Discharge Probe Offset Value	0 °C
High Stage Compressor Discharge Probe Offset Value	0 °C
Heat Exchanger Probe Offset Value	0 °C
High Stage Condenser Discharge Probe Offset Value	0 °C
Unit ID	Serial number entered at factory
Date Format	MM/DD/YYYY
Day	Not affected (maintained in real-time clock)
Month	
Year	
Time Format	12-hour
Minute	Not affected (maintained in real-time clock)
Hour	
AM/PM	
Language	Language previously selected during setup
Temperature Units	°C
Password Protection (for Settings screen)	On
Ambient Temperature Display	On
LN ₂ / CO ₂ System Input	Off
USB Port	On
Access Control as Home Page	On
High Chamber Temperature Alarm Setpoint	-70.0 °C
High Chamber Temperature Alarm Time Delay	0 minutes
Low Chamber Temperature Alarm Setpoint	-90.0 °C
Low Chamber Temperature Alarm Time Delay	0 minutes
High Ambient Temperature Alarm Setpoint	30.0 °C
High Ambient Temperature Alarm Time Delay	15 minutes
Low Ambient Temperature Alarm Setpoint	15.0 °C
Low Ambient Temperature Alarm Time Delay	15 minutes
Power Failure Alarm Time Delay	1 minute
Sensor Failure Alarm Time Delay	0 minutes
Door Open Alarm Time Delay	1 minute
Chamber Setpoint	-80.0 °C
Chamber Hysteresis	0.1 °C
Delay on Start-Up	1 minute

Restore Settings

1. Touch the **i.C³ Settings** icon.
2. Scroll down and touch the **Restore Factory Settings** button. The Restore Factory Settings confirmation box appears.
3. Touch  to confirm, or  to cancel.

Edit Factory Settings

Several of the i.C³ screens and functions are configured at the factory. The screens and functions listed below are set at the factory and may be changed at the direction of Helmer Technical Service.

Factory Settings

Setting	Description
Device Control Settings Screen	Toggle the Device Control Settings screen ON or OFF
Alternate Home Screen	Toggle the Alternate Home screen ON or OFF
Access Control Screen	Toggle the Access Control screen ON or OFF

4 Maintenance

Maintenance tasks should be completed according to the schedule below.

NOTICE

- Maintenance should only be performed by trained refrigeration technicians.
- Review all safety instructions prior to performing maintenance.

Notes

- It is important to ensure that all scientific equipment is maintained regularly for optimum performance.
- These are recommended minimum requirements. Regulations for your organization or physical conditions at your facility may require maintenance items to be performed more frequently, or only by designated service personnel.

Preventive Maintenance Schedule

Task	Frequency			
	Quarterly	Annually	2 years	As Needed
Verify the monitor/chamber temperature sensor accuracy. Calibrate the sensor if necessary.		✓		
Verify the ambient temperature sensor accuracy. Calibrate the sensor if necessary.		✓		
Test the High and Low chamber and Ambient Temperature alarms.	✓			
Test the Power Failure alarm (as required by your organization's protocols).				✓
Test the Door Open alarm.		✓		
Inspect electrical components and wiring terminals in the electrical box for discoloration. Contact Helmer Technical Service if any discoloration is found.		✓		
Inspect and clean or replace the condenser filter.	✓			
Replace the i.C ³ back-up battery			✓	
Defrost and clean the chamber, exterior door gasket, and inner doors.				✓

NOTICE

- Inspect and clean or replace the condenser filter as directed in the maintenance schedule, or when prompted by the i.C³ control and monitoring system.
- The Clean Filter alarm monitors the condition of the air filter as a safety measure. The alarm is designed to warn if the filter media becomes clogged such that freezer operation and product integrity will be affected.
- The Clean Filter alarm could indicate a failure of the condenser fan.

Notes

- During a power failure, the back-up battery provides power to the monitoring system, power failure alarm, and chart recorder (if equipped). If the back-up battery is not functioning, the power failure alarm will not be activated.
- If the back-up battery does not provide power to the monitoring system during the power failure alarm test, replace the battery.
- During a power failure, the Access Control lock will continue to secure the door. To access the freezer during a power failure, the override key must be used.

4.1 Alarm Tests



Test alarms to ensure they are working correctly. The freezer has alarms for primary monitor high temperature, primary monitor low temperature, door open (time), high ambient temperature, low ambient temperature, and power failure.



Use appropriate gloves when handling cold interior components and stored inventory.

NOTICE

Avoid sharp edges when working inside the refrigeration compartment.

Notes

- Before testing alarms, protect items in freezer from extended exposure to adverse temperature.
- If the Settings screen is password protected, enter the appropriate password. If viewing settings for the first time, enter factory default password of "1234".
- If the i.C³ monitoring and control system did not display the appropriate alarm during the alarm test, contact Helmer Technical Service.
- Temperature sensors are fragile; handle with care.

Primary Monitor Probe High Temperature Alarm Test

Notes

- The primary monitor high temperature alarm test should require no more than 90 seconds.

Test the high alarm

1. Touch, **i.C³ APPS, Settings, Alarm Settings** and record the high alarm setting.
2. Move contents within the freezer to gain access to the primary monitor probe.
3. Using a heat gun or similar auxiliary heat source (use low setting if available), apply short bursts of heat to the probe.
4. Observe the temperature on the i.C³ display at which the high temperature alarm activates.
5. The alarm should activate within 2.0 °C of the high alarm setpoint. If the value is more than 2.0 °C different, contact Helmer Technical Service for further instruction.
6. Remove the heat gun, replace the contents of the freezer and close the doors.

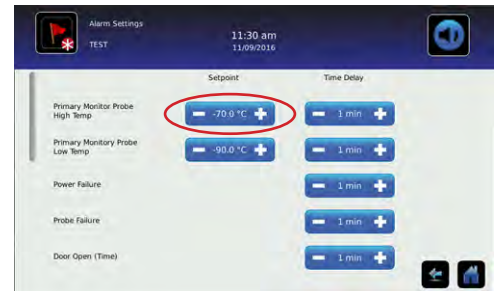

Primary Probe Low Temperature Alarm Test

To simulate a low temperature alarm condition, raise the low alarm temperature setpoint to a point above current chamber temperature displayed on the i.C³ monitoring and control system.

The Primary Probe low temperature alarm test does not test the accuracy of the alarm, but rather verifies the alarm is functional.

Test the low alarm

1. Touch, **i.C³ APPS, Settings, Alarm Settings**.
2. Touch the plus (+) on the Primary Monitor Probe Low Temperature spin box to change the value to 0 °C. The low temperature alarm will activate immediately.
3. If the low temperature alarm does not activate, contact Helmer Technical Service.
4. Touch the minus (-) on the Primary Monitor Probe Low Temperature spin box to return to the original setting.

Power Failure Alarm Test

During a power failure, the power failure alarm activates and the back-up battery provides power to the monitoring system.

Note

Do not switch the back-up battery switch **Off** during the power failure test.

Test the power failure alarm

1. Touch, **i.C³ APPS, Settings, Alarm Settings.**
2. Touch the minus (-) or plus (+) on the Power Failure spin box to change the value to 0 minutes.
3. Switch AC ON/OFF switch **OFF**. The power failure alarm will activate immediately.
4. Switch AC ON/OFF switch **ON**. The power failure alarm will clear and audible alarm will cease.
5. Touch the minus (-) or plus (+) on the Power Failure spin box to return to the original setting.

Door Open Alarm Test

Test the Door Open (Time) alarm

1. Touch, **i.C³ APPS, Settings, Alarm Settings.**
2. Touch the minus (-) or plus (+) on the Door Open (Time) spin box to change the value to 0 minutes.
3. Open freezer door. The door open alarm will activate immediately.
4. Close freezer door. The door open alarm will clear and audible alarm will cease.
5. Touch the minus (-) or plus (+) on the Door Open (Time) spin box to return to the original setting.

High Ambient Temperature Alarm Test

Note

Emergency Mode alarm may occur during this test. Turn back-up battery switch and main power switch OFF. After 10 seconds turn back-up battery switch and main power switch ON to clear Emergency Mode alarm.

Test the High Ambient Temperature Alarm

1. Touch, **i.C³ APPS, Settings, Alarm Settings**
2. Scroll down and record the Ambient Probe High Temp setpoint.
3. Remove the condenser filter grill.
4. Using a heat gun or similar auxiliary heat source (use low setting if available), apply short bursts of heat to the ambient temperature probe.
5. Observe the temperature on the i.C³ display at which the high ambient temperature alarm activates.
6. The alarm should activate within 2.0 °C of the high alarm setpoint. If the value is more than 2.0 °C different, contact Helmer Technical Service for further instruction.
7. Remove the heat gun and reinstall the condenser filter grill.

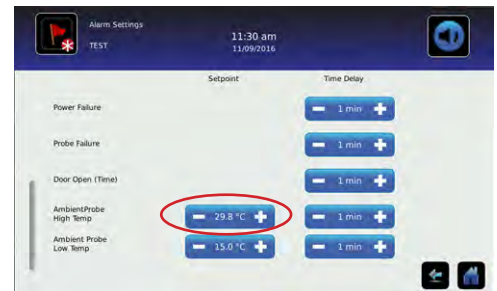

Low Ambient Temperature Alarm Test

☑ Test the Low Ambient Temperature Alarm

1. Touch, i.C³ APPS, **Settings, Alarm Settings**
2. Scroll down and record the low ambient alarm setpoint.
3. Touch the minus (-) on the Low Ambient Time Delay setting spin box to change the setting to 0 minutes.
4. Lift the condenser grill from the magnetic anchor points at the top of the grill. Remove by pulling the grill forward to an approximate 30° angle and lifting the tabs out of the tab holes.
5. Using a half-full glass of ice and water mixture, dip a clean rag or paper towel into the ice water mixture until saturated.
6. Wrap the moistened rag or towel around the ambient probe, and observe the ambient display temperature begin to drop.
7. Observe the ambient temperature on the i.C³ display at which the low ambient temperature alarm activates.
8. Compare the recorded temperature at which the alarm activated to the low ambient alarm setpoint. The recorded temperature should be within 1°C of the low ambient alarm setpoint. If the alarm triggers outside of the +/- 1°C range, verify sensor calibration.
9. Remove moistened rag or towels from the sensor, and replace the condenser grill.
10. Touch the plus (+) on the Low Ambient Time Delay setting spin box to return to the original setting.

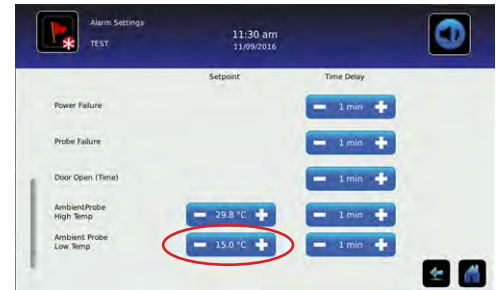

Non-configurable Temperature Alarms

Some temperature alarms are not user-configurable. As such, the alarm setpoint cannot be changed to simulate a high temperature alarm.

Due to the inaccessibility of the temperature sensor, it is not recommended an alarm condition be manually simulated for these alarms.

Non-configurable Temperature Alarms

- ◆ Low Stage Compressor Discharge Temperature Alarm
- ◆ High Stage Compressor Discharge Temperature Alarm
- ◆ High Stage Condenser Discharge Temperature Alarm
- ◆ Cascade Heat Exchanger Temperature Alarm

4.2 Upgrade System Firmware

Helmer may occasionally issue updates for the i.C³ firmware. Follow upgrade instructions included with the firmware update.

4.3 Test and Replace Back-up Battery

i.C³ Monitoring System Back-up Battery

On all i.C³ screens, the Battery icon will appear in the header bar when the system is running on battery power and the screen brightness will automatically be reduced. The monitoring system will automatically disable some features to extend battery life.

☑ Test the i.C³ Monitoring System back-up battery

1. Turn the AC On/OFF switch **OFF**. The screen should continue to display information with reduced brightness and the battery icon will appear on the screen.
2. If the display is blank, replace the battery.
3. Switch AC ON/OFF switch **ON**.

Note

Use only a battery which meets manufacturer's specifications.

Replace Monitoring System Back-up Battery

The monitoring system back-up battery is a serviceable part and available by contacting Helmer Technical Service. The battery is located on the left side behind the electrical compartment access panel below the chamber. Refer to the installation instruction included with the battery service kit.

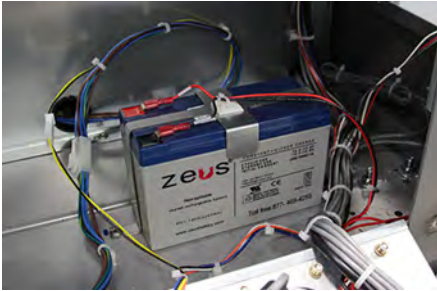

Back-up battery (monitoring system / access control / optional chart recorder)



Removal of the electrical compartment access panel will expose electrical wiring carrying line voltage and control voltage. Ensure the freezer is powered off before removing the access panel.

NOTICE

Avoid sharp edges when working inside the electrical compartment.

Notes

- Stored inventory may be kept in the freezer while this procedure is performed.
- It is recommended the chamber door not be opened until after this procedure is completed.

4.4 Defrost Ultra-Low Freezer

Frost accumulation is normal. The freezer chamber and interior doors must be periodically defrosted to prevent excessive frost from interfering with door operation and storage of product, or the freezer's ability to maintain temperature.

If the freezer door or interior doors do not operate correctly, or if the freezer cannot maintain the chamber setpoint temperature, defrost the chamber.

Defrost and Clean Interior Doors

Defrost the interior doors according to the preventive maintenance schedule provided in this manual.



Use appropriate gloves when handling cold interior components.

Notes

- This procedure does not require the freezer door to remain open for an extended period of time.
- Stored inventory may be kept in the freezer while this procedure is performed.
- Do not use warm water to defrost the interior doors.
- A heat gun may be used to defrost the interior doors

Defrost interior doors

1. Open chamber door.
2. Open interior door and lift upward to free the hinge pins from hinges to remove.
3. Close chamber door.
4. Allow interior door to set for approximately four hours to allow accumulated frost to melt. After four hours, verify interior door is free of frost and moisture in metal framework.
5. Clean interior door with a soft cotton cloth and non-abrasive liquid cleaner.
6. Wipe door with a dry cotton cloth to remove moisture.
7. Reinstall interior door by aligning the hinge pins on the door with the hinges in the cabinet and lowering the interior door

Defrost and Clean Chamber



- Do not use a secondary heat source to defrost the freezer. The use of an electrical heat source (such as a heat gun) could create an electrocution hazard if the user comes into contact with water from the defrosted chamber.
- Use appropriate gloves when handling cold interior components and stored inventory.

NOTICE

- Keep hands away from pinch points when closing the door.
- Defrosting the freezer will create excessive water in the work area. Take necessary precautions to prevent slip hazards.
- Before defrosting chamber, protect items in freezer from extended exposure to adverse temperature.
- Do not use a secondary heat source to defrost the freezer. The use of a secondary heat source (such as a heat gun) may create additional pressure within the refrigeration system and may damage system components.
- Allow chamber temperature to stabilize at setpoint before moving product back into the freezer.

Note

All moisture must be removed before powering the freezer on. Any remaining moisture will re-freeze in the chamber and may require more frequent defrosting than indicated in the preventive maintenance schedule.

Defrost the chamber

1. Move stored product to an equivalent freezer.
2. Switch back-up battery ON/OFF switch **OFF**; switch AC ON/OFF switch **OFF**; and disconnect the AC power cord from the power receptacle and remove from freezer.
3. Move the freezer to a location where water can be captured as the chamber thaws, preferably close to a floor drain.
4. Open the chamber door. Prop the door open, ensuring the method used does not damage the door gasket.
5. Remove and defrost the interior doors.
6. Allow the freezer to set for 24 hours to allow accumulated frost to melt. After 24 hours, check to verify that the interior is free of frost.
7. Clean interior surfaces and door gasket with soft cotton cloth and non-abrasive liquid cleaner.
8. Wipe the interior surfaces and door gaskets with a dry cotton cloth to remove moisture.
9. Reinstall the interior doors.
10. Close the chamber door.
11. Remove any accumulated moisture from the floor.
12. Move the freezer to the original location.
13. Reattach the AC power cord to the freezer.
14. Reconnect the AC power cord into the power receptacle; switch AC ON/OFF switch **ON**; and switch back-up battery ON/OFF switch **ON**.
15. Touch **Mute** to disable the high temperature alarm while freezer reaches operating temperature.
16. Once the freezer reaches the setpoint it is ready for use.
17. Return stored product to the freezer.

Defrost and Clean Exterior Door Gasket

If the exterior door gasket has excessive frost or ice build-up and requires defrosting, Helmer recommends defrosting the entire chamber. After defrost is complete, carefully inspect the door gasket for tears or damage, and ensure proper adhesion to the exterior door.

4.5 Clean Ultra-Low Freezer



Disconnect the freezer from AC power prior to cleaning the condenser with a liquid cleaner to prevent an electrocution hazard.

NOTICE

- Avoid sharp edges when removing and installing the condenser grill and filter.
- Use appropriate gloves when handling stored inventory.
- Protect items in freezer from extended exposure to adverse temperature.
- Allow chamber temperature to stabilize at setpoint before moving product back into the freezer.

Condenser

Clean the condenser

1. Lift the condenser grill upward and pivot the top edge away from the freezer. Then lift the bottom edge of the grill upward to disengage the tabs at the bottom of the grill from the freezer base and remove.
2. Clean the condenser using a soft brush and a vacuum cleaner.
3. Reinstall the condenser grill by inserting the tabs at the bottom of the grill into the corresponding holes in the freezer base. Pivot the top of the grill toward the freezer until the magnets engage.

Condenser Filter

In environments where freezer is exposed to excessive lint or dust, the condenser filter may require cleaning or replacing more frequently than stated in preventive maintenance schedule. Both reusable and disposable filters are available by contacting Helmer Technical Service.



Reusable Condenser Filter



Disposable Condenser Filter

Clean the reusable condenser filter

1. Pivot the top of the condenser grill away from the freezer.
2. Lift the filter upward and remove from the slots on the back of the grill.
3. Clean the condenser filter with warm water and a mild detergent.
4. Rinse the filter under warm water. The filter must be rinsed from back to front so water flows in the opposite direction of the airflow.
5. Allow the condenser filter to dry thoroughly.
6. Reinstall the condenser filter by inserting the filter into the slots on the back of the grill. The filter must be installed so the wire mesh faces toward the condenser (inside).
7. Pivot the top of the grill toward the freezer until the magnets engage.

Exterior

Clean the exterior surfaces of the unit with a soft cotton cloth and non-abrasive liquid cleaner.

i.C³® Touchscreen

Note

Do not use solvent or alcohol-based cleaners to clean the i.C³ touchscreen.

Clean the i.C3 touchscreen with a soft, dry cotton cloth.

5 Service

5.1 Refrigerant

NOTICE

- Review all safety instructions prior to recharging refrigerant.
- Maintenance should only be performed by trained refrigeration technicians.
- Avoid sharp edges when working inside the refrigeration compartment.
- The refrigeration systems are sealed at the factory. Do not connect gauge manifolds or add refrigerant to either system unless directed by Helmer Technical Service.

Full initial refrigerant charge varies by models and can be found on the chart below.

Refrigerant Charge

Model	118	126
High Stage Refrigerant	R290	
Low Stage Refrigerant	R170, R290	
High Stage Initial Charge	5.22 oz. (148 g +/- 1.0 g)	
Low Stage Initial Charge (R170)	3.11 oz. (88 g +/- 1 g)	3.46 oz. (98 g +/- 1 g)
Low Stage Initial Charge (R290)	0.21 oz. (6 g +/- 1 g)	0.21 oz. (6 g +/- 1 g)

5.2 Chamber Temperature Sensor Error Recovery

If the i.C³ monitoring and control system loses communication with the chamber temperature sensor or if the sensor fails, the i.C³ system will operate the refrigeration system in Emergency Mode to preserve the inventory stored in the freezer.

Notes

- The Emergency Mode alarm will be displayed on the Home screen only.
- If the Emergency Mode alarm is active, contact Helmer Technical Service.

When the refrigeration system is operating in Emergency Mode, the high stage compressor will operate continuously and the low stage compressor will operate normally, unless one or more of the following conditions occur:

- ◆ An over-pressure condition in the high stage refrigeration system
- ◆ A second Sensor Failure alarm (compressor temperature, condenser temperature, or heat exchanger temperature) becomes active beyond the duration specified in the Sensor Failure time delay setting
- ◆ The cascade temperature goes above -15°C

The high stage and low stage compressors will be automatically powered off if any of the conditions above are met.

The chamber temperature sensor error may be cleared and the freezer returned to normal operation by following the chamber temperature sensor error recovery procedure.

NOTICE

Protect items in freezer from extended exposure to adverse temperature.

Perform error recovery

1. Switch back-up battery ON/OFF switch **OFF**; switch AC ON/OFF switch **OFF**.
2. Wait 30 seconds before powering the freezer back on.
3. Switch AC ON/OFF switch **ON**; switch back-up battery ON/OFF switch **ON**.

5.3 Access Control Solenoid

In the event of an Access Control Solenoid failure, the freezer must be accessed with the override key. The Access Control Solenoid is a serviceable assembly installed in the door.

Replace Access Control Solenoid

Contact Helmer Technical Service to order Access Control Solenoid service kit. Follow instructions for replacement included with the service kit.

5.4 Exterior Door

Replace Hinges and/or Covers

Cracked or broken hinges or hinge covers can be replaced. Contact Helmer Technical Service to order Hinge and Cover service kit. Follow instructions for replacement included with the service kit.



Exterior door hinge with covers

Adjust Exterior Door Gap

Notes

- It is not necessary to power the freezer off prior to performing this procedure unless required by your facility standard operating procedures.
- Prior to making door adjustments, contact Helmer Technical Service to obtain a copy of the factory door gap measurements.
- Door gap adjustments can be made using the slotted hardware mounting points on the door hinge.
- Gap measurements on the hinge side of the unit should be taken 1" below the top hinge and 1" above the center and lower hinges.
- Gap measurements on the handle side should be taken 2" below the top corner, 2" above the bottom corner and 1" above the handle.
- Frost and/or snow build-up inside the cabinet can indicate which hinge(s) need to be adjusted.
- Multiple adjustments may be necessary to ensure a tight seal.

Required tools:

- #1 Phillips screwdriver
- #20 Torx driver
- Digital calipers
- Loctite 242
- #2 Phillips screwdriver
- 1/2" Box wrench
- Straight edge/ruler

1. Obtain a copy of the original factory door gap measurements.
2. Using digital calipers, measure the gap between the door plastic mullion and the cabinet plastic mullion to verify if there is any deviation the original factory measurement as.
3. Using a #2 Phillips screwdriver, remove the screws securing the hinge covers. Remove hinge covers and set screws and hinge covers aside.
4. On the door-side of the hinge, use a pen or marker to mark where the screw threads in, this will make it easier to visually track adjustments made.
5. Using a #1 Phillips screwdriver, loosen the four screws in door-side of the hinge and open the door.
6. As the door is closed the hinge screws can be shifted in the slotted mounting points to achieve the desired gap.
7. Tighten the four screws in the door-side of the hinge using a #1 Phillips screwdriver.
8. Using digital calipers, measure the door gap and compare to the original factory setting.
9. Reinstall hinge covers on the hinge.
10. Using a #2 Phillips screwdriver, reinstall the screws securing the hinge covers.



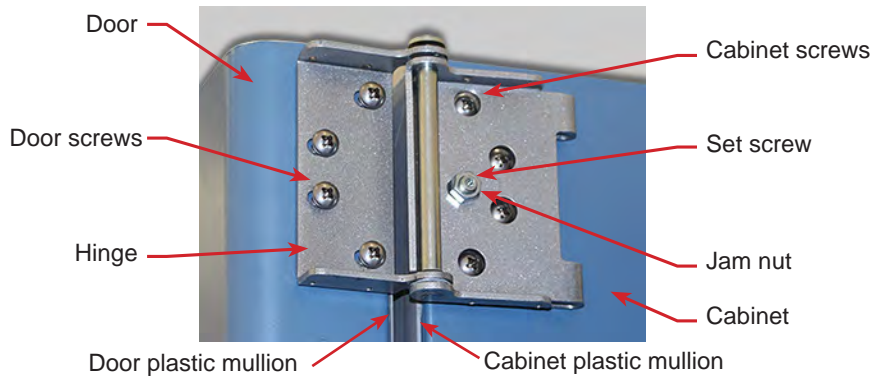

Notes

- The door will need to be adjusted if drag or force is required to turn the door-lock key.
- Do not assume a door adjustment is necessary by visual assessment or level.
- Prior to making any adjustments to the door hinge(s), ensure the set screw is sufficiently seated in the hinge.
- Adjust the top or bottom hinge to adjust the door camber. Starting with the bottom hinge is recommended.

Adjust Door Camber

1. Using a #2 Phillips screwdriver, remove the screws securing the hinge covers. Remove the hinge covers and set the screws and hinge covers aside.
2. Loosen the jam nut with a 1/2" box wrench (This will allow you to adjust the set screw).
3. Tighten the set screw clockwise one single rotation with the #20 Torx driver.
4. Tighten the jam nut with 1/2" box wrench.
5. Open and close the door. Once closed, confirm the key movement is smooth. If not, repeat steps 2 through 4.

Note

If the key movement has become more difficult, loosen the set screw rather than tighten.

6. Reinstall the hinge covers on the hinge.
7. Using a #2 Phillips screwdriver, reinstall the screws securing the hinge covers.



5.6 Casters

If a caster is bent or broken, it can be replaced. Contact Helmer Technical Service to order a Caster service kit. Follow instructions for replacement included with the service kit.

6 Troubleshooting

NOTICE

- Review all safety instructions prior to troubleshooting.
- Troubleshooting should only be performed by trained refrigeration technicians.

NOTE

To order Replacement Parts, contact Helmer Technical Service (1-800-743-5637).

6.1 General Operation Problems

Problem	Possible Cause	Action
The exterior door does not open easily.	Exterior door handle bushings are worn.	Confirm the exterior door handle is firmly attached to the freezer door. Replace the door handle bushings if the handle is loose.
	Excessive frost or ice build-up on mullion because cleaned or defrosted gasket and closed while still wet.	Defrost the interior and verify it is dry before closing door.
An interior door does not open easily.	Frost accumulation around the interior door gasket.	Defrost the interior door.
	Interior door hinge is bent.	Replace the interior door hinge.
	Interior door retaining clip is worn or bent.	Replace the interior door retaining clip.
The monitor display is difficult to read.	Screen brightness is set too low.	Change the screen brightness. Touch i.C ³ APPS, Brightness. Touch the icon corresponding to the desired brightness setting.
The monitoring system is not responding.	Digital electronics are locked because of an interruption in power.	Reset the monitoring system by turning battery and AC power off and back on.
"Refrigeration System" alarm is displayed on the monitor.	Refrigerant pressure or temperature is too high due to improper airflow.	Ensure that freezer has been installed with proper clearances.
		Check that ambient temperature is in the acceptable range.
		Check the air filter and condenser face, and clean or replace as needed.
		Check condenser face, clean as needed.
		Check the operation of the condenser fan, and repair or replace as needed.
	Refrigerant pressure or temperature is too high because the freezer is not being used as intended.	Ensure that products being placed in the freezer are pre-frozen to avoid introducing an excessive heat load.
	Refrigerant pressure or temperature is too high because the low stage compressor is not operating when it should be.	Check the status of the low stage compressor. Touch i.C ³ APPS, Settings (enter the Settings password), Device Status. Scroll as needed to view the compressor status.
		Verify CP is initiating SSR2 to be ON by checking that the LED for SSR2 is lit.
Verify control voltage is leaving the SSR2 relay.		
Check the line voltage high pressure switch, ensuring switch is closed.		
	Check the low stage compressor inverter.	
Refrigerant pressure or temperature is too high because the high stage compressor is not operating when it should be.	Contact Helmer Technical Service.	
One or more system components has failed.	Contact Helmer Technical Service.	
"Sensor Failure" alarm is displayed on the monitor.	One or more of the temperature sensors has failed, or sensor wiring is an open circuit.	Check the i.C ³ Event Log Detail screen for the specific sensor failure. Touch i.C ³ APPS, Information Logs, Event Logs. Touch the individual event to view the sensor failure code.
		Check the sensor wire connection to the control board and secure the connection if necessary.
		Confirm the sensor is providing resistance in the range of 73 Ω to 110 Ω. Replace the sensor if resistance is outside of specified range.

Problem	Possible Cause	Action
The chart recorder is not marking the temperature.	The chart paper knob is not tight.	Tighten the chart paper knob.
	Stylus pressure is not correct.	Confirm stylus is pressing firmly against paper.
	The chart recorder motor has stopped running.	Remove the chart paper and press the reset button (behind the chart paper). Reinstall the chart paper.
	The chart recorder is defective.	Replace the chart recorder.

6.2 Chamber Temperature Problems

Problem	Possible Cause	Action
The freezer triggers an "Emergency Mode" alarm when performing a high temperature alarm test.	Temperature reading of chamber probe is too high.	Clear alarm by turning the back-up battery switch and the main power switch OFF. After 10 seconds, turn back-up battery switch and main power switch ON.
The "clean Filter" alarm is activated.	The condenser filter is dirty/clogged.	Clean or replace the condenser filter, then acknowledge the clean filter alarm in the event log to clear the alarm.
	The condenser fan is not operating.	Verify the fan is not physically impeded and check voltage going to the fan motor. Replace if necessary.
The chamber temperature displayed is higher or lower than the actual temperature.	Chamber temperature sensor is not calibrated.	Check the chamber temperature calibration. Change the calibration if necessary.
	Connections for the chamber temperature sensor are loose.	Check the sensor wire connection to the control board and secure the connection if necessary.
		Check the continuity of the sensor wiring. Replace the sensor if necessary.
		Confirm the sensor is providing resistance in the range of 73 Ω to 110 Ω . Replace the sensor if resistance is outside of specified range.
		Check the CP performance by utilizing jumper at J11. Place the jumper across both pins. The screen should display 4.0°C +/-1°C.
	Digital electronics are locked because of an interruption in power.	Reset the monitoring system by turning battery and AC power off and back on.
	Compressor solid state relay is faulty.	Confirm the relay is operating correctly. Replace the relay if necessary.
A component is faulty or internal connections are loose.	Contact Helmer Technical Service.	
The compressors run continuously.	Freezer setpoint is set too low.	Confirm the setpoint is set within the operating range and change it if necessary.
	Chamber temperature sensor is not calibrated.	Check the chamber temperature sensor calibration. Change the calibration if necessary.
	Compressor solid state relays are faulty.	Confirm the control board indicates both compressors should not be running. Touch i.C ³ APPS, Settings (enter the Settings password), Device Status.
		If both compressors should not be running, check the compressor solid state relays.
		If the compressor solid state relays are closed, replace the relays.
	i.C ³ control board is faulty.	Confirm the control board is calling for both compressors to be running. Touch i.C ³ APPS, Settings (enter the Settings password), Device Status.
If both compressors should be running, no further action is needed.		
If both compressors should not be running, check the control board compressor relays. If the relays are closed, replace the control board.		
The chamber temperature meets an alarm condition, but the appropriate temperature alarm is not active.	Temperature alarm setpoint was changed.	Check the current setpoints for the temperature alarms. Change the setpoints if necessary (refer to Section II, Item 8.3.1).

Problem	Possible Cause	Action
The chamber temperature does not reach or stabilize at setpoint.	Ambient air temperature is too high.	Confirm freezer location meets requirements.
	Warm product was placed at sensor.	Move product and monitor chamber temperature. Wait to see if temperature has stabilized or lowers.
		Check remaining items.
	Excessive frost has accumulated in the chamber.	Defrost chamber.
	Temperature control sensor is faulty.	Check accuracy of temperature probe.
		Confirm the sensor is providing resistance in the range of 73 Ω to 110 Ω. Replace the sensor if resistance is outside of specified range.
		Install jumper across J11 on the CP board: Display 4°C +/-1 - NO call Helmer Technical support.
		Display 4°C +/-1 - YES - CP board process is good, check connections at CP board and under connector pin, wait 8 hours to see if unit stabilizes.
	Condenser filter is dirty.	Check condenser filter, clean or replace as needed.
	Condenser fan running slowly or not at all.	Check voltage and wiring to fan motor at connector.
		Check voltage output at CP board relay J42.
		Replace motor.
	Low stage compressor starting and stopping after 2 to 10 minutes run time.	Check cascade temperature - touch i.C ³ Settings (enter password) / Device Status - Cascade temperature maintaining below -15°C. - NO - Contact Helmer Technical Service. - YES - During pull down and starting at ~-35°C - normal behavior. - YES - Check compressor amperage, OHMs and compressor inverter.
	High Stage running: Low stage not running.	Check cascade temperature - touch i.C ³ Settings (enter password) / Device Status - Cascade has to reach ~-35°C before low stage will start. Did cascade reach ~-35°C? - NO - contact Helmer Technical Service. - YES - it is normal to see the cascade heat exchanger elevate above -35°C and could reach -15°C; if this happens the low stage will cycle off NORMALLY, until the low stage reaches ~-35°C and the low stage will start again. This is most typical during pull down. At normal operation when at setpoint, this will not occur.
		Check i.C ³ Control board for lit compressor LEDs (D21 and D22) to energize compressor relays - ON, check remaining items: OFF - Contact Helmer Technical Support.
		Check i.C ³ Control board for lit compressor LEDs (D21 and D22) to energize compressor relays - ON, check remaining items: OFF - Contact Helmer Technical Support.
		Check solid state relay - replace if control power is present but relay is not allowing voltage to pass.
		Verify operation of High pressure switch(s) control and line is not open.
		Check start components.
		Contact Helmer Technical Service.
Compressor(s) not running		Check power to unit.
Compressor(s) not running	Verify call for both compressors - touch i.C ³ settings (enter password) Device Status - call for both on. - NO - Reboot. - YES - Check remaining items.	
	Check i.C ³ Control board lit compressor LEDs (D21 and D22) to energize compressor relays. - OFF - Contact Helmer Technical Support. - ON - Check remaining items.	
	Check solid state relay. Replace if control power is present but relay is not allowing voltage to pass.	
	Check compressor inverter connections. Replace inverter if necessary.	
	Amperage check and OHM compressor. Contact Helmer Technical Support.	

Problem	Possible Cause	Action
	Both compressors running.	Check cascade temperature - touch i.C ³ settings (user password) / device status and history - Cascade temperature maintaining below -15°C BUT greater than -50°C. Normal. Allow to stabilize. Cascade temperature -50°C or colder. Oil logging. Defrost unit. Low stage low on charge. Contact Helmer Technical Support to utilize tech service thermocouples.

6.3 Alarm Activation Problems

Problem	Possible Cause	Action
The freezer is in an alarm condition, but alarms are not audible.	Audible alarms are muted.	Verify that audible alarms are not muted. If time remaining is greater than five minutes, change MUTE timer value to five minutes and wait until timer resets. Check alarm volume level and tone selection. Touch i.C ³ Settings (enter password) / Sound Settings.
	i.C ³ control board is faulty.	Confirm the control board is operating correctly. Replace if necessary.
	Speaker is faulty.	Replace display assembly.
	A component is faulty or internal connections are loose.	Contact Helmer Technical Service.
The freezer meets an alarm condition, but the appropriate alarm is not active.	Alarm setpoint was changed.	Check the current setpoints for the alarms.
	A component is faulty or internal connections are loose.	Contact Helmer Technical Service.
The High Temperature alarm activates when the door is opened, then clears shortly after the door is closed.	High temperature alarm setpoint is set too low.	Check the setpoint and change it if necessary.
	Connections for the chamber temperature sensor are loose.	Check the sensor wire connection to the control board and secure the connection if necessary.
	A component is faulty or internal connections are loose.	Contact Helmer Technical Service.
The freezer is connected to power, but the AC Power Failure alarm is active.	Outlet connection is faulty.	Verify power at the outlet. Repair the original outlet or connect to a different outlet if necessary.
	Power cord is faulty.	Confirm the power cord is connected securely. Secure the power cord if necessary.
	Plugged into GFI/GFCI outlet.	Move to standard outlet. Helmer does not recommend operating this unit on a GFI outlet.
	ON/OFF AC power switch is faulty.	Replace the ON/OFF AC power switch.
	ON/OFF AC power switch is OFF.	Switch the ON/OFF AC power switch ON.
	A component is faulty or internal connections are loose.	Contact Helmer Technical Service.
	Circuit breaker is tripped.	Reset the circuit breaker.
	Circuit breaker is faulty.	Replace the circuit breaker.
	Power supply board is faulty.	Replace the power supply board.
Power filter is faulty.	Replace power filter.	
The Door Open alarm is activating sporadically.	Exterior door is not closing completely.	Confirm the hinges are not damaged. Replace the hinges if necessary.
	Exterior door is closing but not sealing completely.	Defrost the exterior door gasket.
	Connection for the exterior door switch is loose.	Test the switch wiring connection and secure the connection if necessary.
	Exterior door switch is faulty.	Replace the magnetic door switch.
	i.C ³ control board is faulty.	Confirm the control board is operating correctly. Replace if necessary.
	Door Open Timeout is set to zero, causing the alarm to activate immediately when the door is opened.	Check the time delay for the Door Open alarm. Change the time delay if necessary.

Problem	Possible Cause	Action
The Condenser Temperature alarm is active.	Condenser filter is dirty.	Check the condenser filter. Clean or replace if necessary.
	Side panels missing from cabinet base.	Reinstall side panels to ensure proper airflow across condenser and compressors.
	Condenser fan is not running.	Check the condenser fan wiring connection. Secure the connection if necessary.
		Check power to the fan and electrical connections. If power to the fan, replace fan. If no power to the fan, call Helmer Technical Support.
		Check the CP operation of relay at J42.
	Connection for the condenser temperature sensor is loose.	Check the sensor wire connection to the control board and secure the connection if necessary.
		Ohm out.
Condenser temperature sensor is faulty.	Check the sensor wire connection to the control board and secure the connection if necessary.	
	Check the continuity of the sensor wiring. Replace the sensor if necessary.	
	Confirm the sensor is providing resistance in the range of 100 Ω to 115 Ω. Replace the sensor if resistance is outside of specified range.	
The No Battery alarm is activating sporadically.	Monitoring system back-up battery voltage is low.	Replace the monitoring system back-up battery.
	Power supply board voltage is incorrect.	Contact Helmer Technical Service.
The High Temperature alarm is activating sporadically.	Chamber temperature sensor is not calibrated.	Check the chamber temperature sensor calibration. Change the calibration if necessary.
	A component is faulty or internal connections are loose.	Contact Helmer Technical Service.

6.4 Icing Problems

Problem	Possible Cause	Action
There is excessive ice in the chamber, on the interior doors, or on the exterior door gasket.	Humid air is entering the chamber.	Verify the door is aligned, gap is within spec, closing tightly, and sealing correctly. Correct issues as necessary.
		Check for tears, loose door gasket, or damaged door gasket. Replace if necessary.
		Defrost the chamber, exterior door gasket, and interior doors if necessary.
	Exterior door is not closing completely.	Defrost the exterior door gasket if necessary
		Confirm the hinges are not damaged. Replace the hinges if necessary.
		Confirm door gaps and alignment are appropriate.
	Relative humidity around freezer is too high.	Check door latch to ensure it is securing and remains secure.
Confirm freezer location meets requirements.		

7 Parts

7.1 Exterior Front and Door

Notes

- Before replacing parts, protect items in freezer from extended exposure to adverse temperature.
- Allow freezer temperature to stabilize at setpoint after replacing parts or after extended door opening.
- The i.C³ display assembly is sensitive to static electricity and can be damaged by electrostatic discharge. Use proper ESD precautions when handling the display assembly.

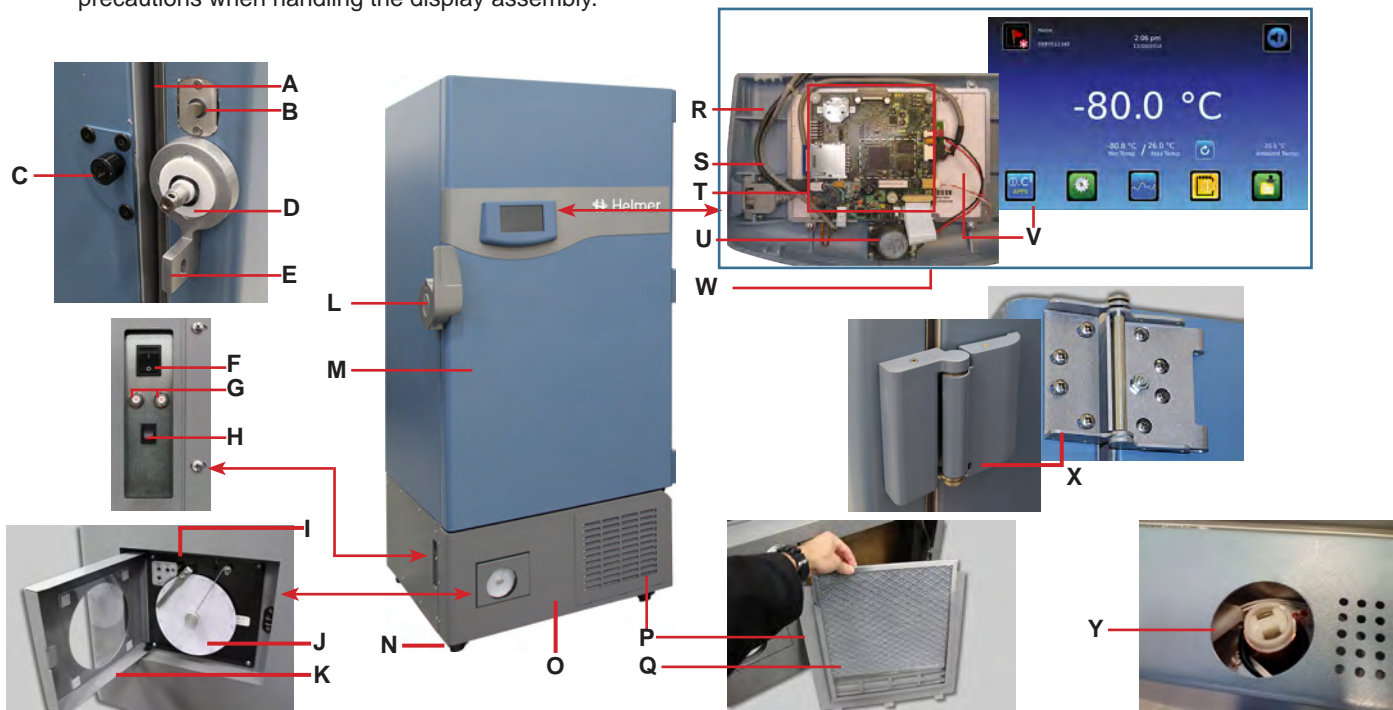

Label	Description	Model	Part #	Label	Description	Model	Part #
A	Exterior door gasket	iUF118	800176-2	Not Shown	Leveling legs	-	800199-1
		iUF126	800177-2	O	Front bezel (with chart recorder door)	iUF118	800190-2
B	Access Control solenoid assembly	-	800195-1			iUF126	800192-2
C	Latch roller	-	800318-1	Not Shown	Front bezel (without chart recorder door)	iUF118	800190-1
D	Door handle bushing	-	800179-1			iUF126	800192-1
E	Padlock hasp	-	-	P	Condenser grill	-	800202-1
F	AC ON/OFF switch	-	800171-1	Q	Condenser grill filter (* = disposable condenser filter)	-	800159-1
G	Circuit breakers	-	800172-1				220583*
H	Monitoring system back-up battery switch	-	800173-1	R	Power cable	-	-
I	Chart recorder	-	800196-1	S	Interface cable	-	120756
J	Chart paper (52 sheets)	-	800197-1	T	Display board	-	800165-1
K	Chart recorder door	-	-	U	Speaker	-	-
L	Door handle with key lock, electronic lock, & padlock hasp	-	-	V	Touchscreen	-	-
M	DOOR (includes handle, handle bushings, gasket, vacuum port, and Access Control solenoid)	-	-	W	Display assembly (includes interface cable, power cable, display board, touch screen, speaker, and bezel)	-	800165-1
N	Caster (swivel with brake)	-	800188-1	X	Hinge assembly (includes hinge and hinge covers)	-	800178-1
				Y	Vacuum port	-	800175-1

7.2 Interior Cabinet

NOTICE

- When removing or replacing storage racks, do not allow the storage rack to set on the top edge of a partially-open interior door.
- To avoid damage to the interior door hinges, do not apply upward or downward force to the interior doors.

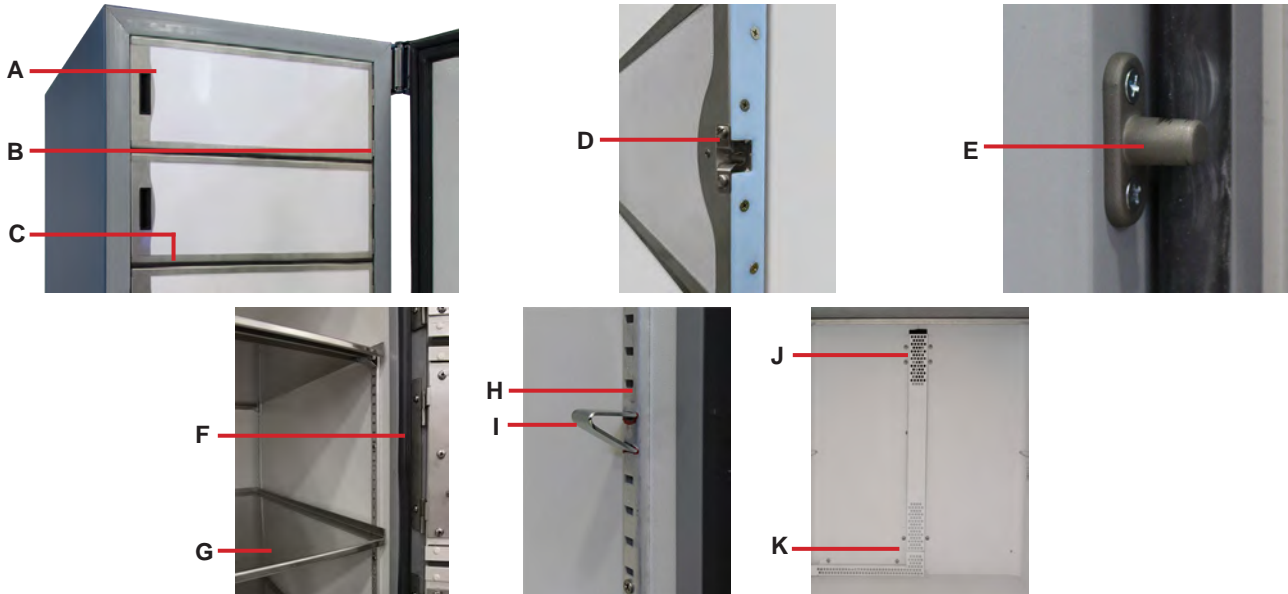

Label	Description	Model	Part #	Label	Description	Model	Part #	
A	Inner door (the inner doors of the top three compartments are 9.25" tall. All other inner doors are 12.25" tall)	iUF118	12.25"	800183-1	F	Inner door mullion gasket	iUF118	800187-1
		iUF118	9.25"	800183-2			iUF126	800187-3
		iUF126	12.25"	800183-3	G	Shelf	iUF118	401044-1
		iUF126	9.25"	800183-4			iUF126	401045-1
B	Inner door hinge	-	800185-1	H	Shelf standard	-	-	
C	Inner door gasket	iUF118	-	800184-1	I	Shelf clip	-	220601
		iUF126	-	800184-3	J	Chamber / chart recorder temperature sensor (behind cover)	-	801261-1
D	Inner door retaining clip	-	800186-1	K	Chamber temperature sensor wire cover	-	-	
E	Inner door catch	-	800186-1					

7.3 Electrical Panel



Disconnect the freezer from AC power before removing the access panel.

NOTICE

Avoid sharp edges when working inside the electrical compartment.

Note

The i.C³ control board is sensitive to static electricity and can be damaged by electrostatic discharge. Use proper ESD precautions when handling the control board.

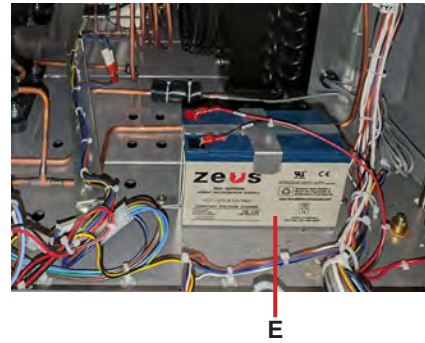
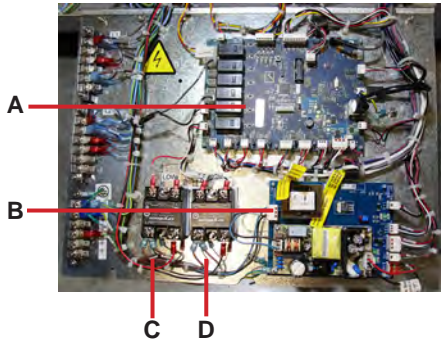

Label	Description	Part #	Label	Description	Part #
A	i.C ³ control board	800167-1	D	High stage compressor relay	800170-1
B	Power supply board	800168-1	E	Monitoring system/Access Control back-up battery	800174-1
C	Low stage compressor relay	800170-1			

7.4 Refrigeration Components and Exterior Rear



Disconnect the freezer from AC power before removing the access panel.

NOTICE

Avoid sharp edges when working inside the electrical compartment.

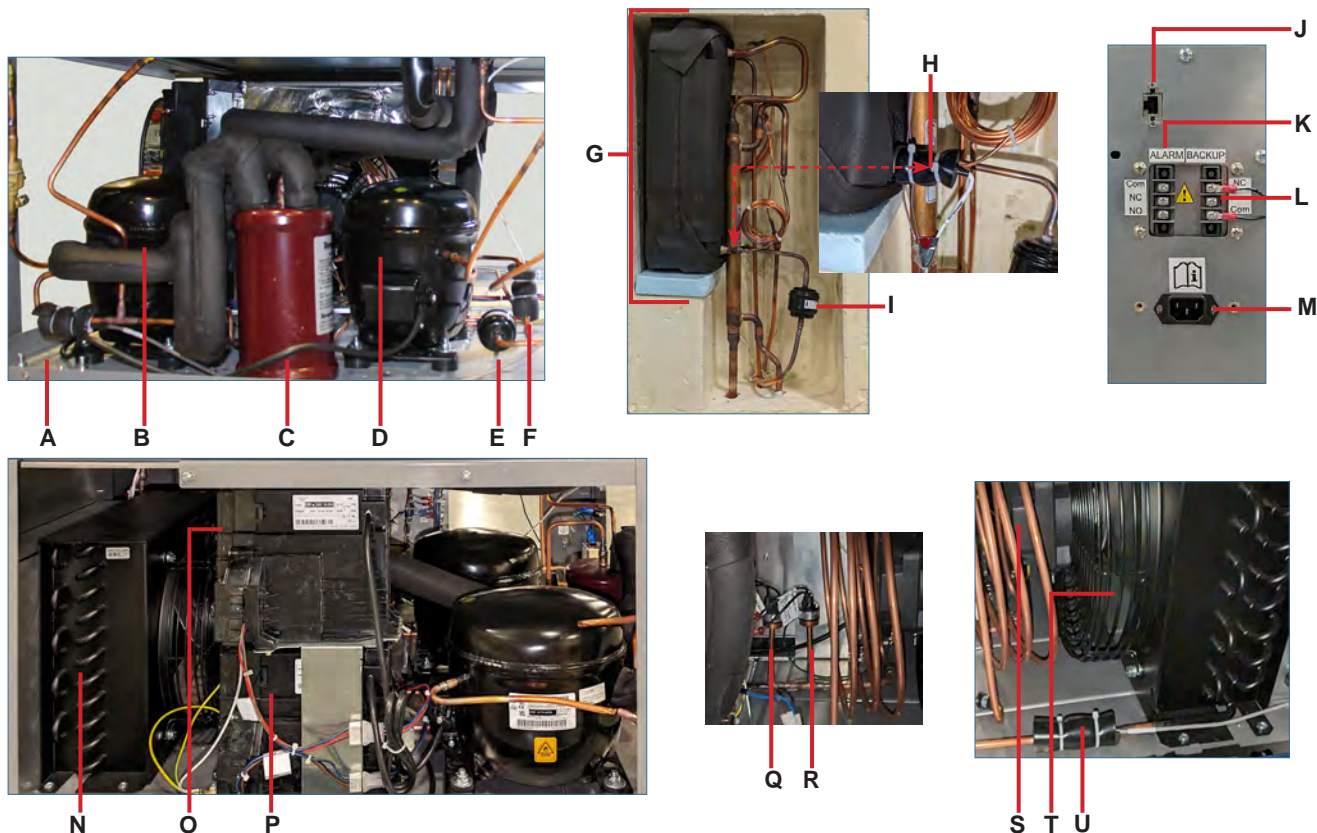

Label	Description	Part #	Label	Description	Model	Voltage	Part #
A	High stage compressor discharge temperature sensor	800169-2	O	Low stage compressor inverter	iUF118	115V	801267-1
B	High stage compressor	801250-1			iUF126	115V	801252-1
C	Oil separator (low stage)	-			iUF118	220-240V	801269-1
D	Low stage compressor	801251-1			iUF126	220-240V	801253-1
E	Dryer (high stage)	220794	P	High stage compressor inverter	iUF118	115V	801268-1
F	Low stage compressor discharge temperature sensor	800169-4			iUF126	115V	801252-1
G	Cascade heat exchanger assembly	801260-1			iUF118	220-240V	801270-1
H	Cascade heat exchanger temperature sensor	800169-5			iUF126	220-240V	801253-1
I	Dryer (low stage)	220794	Q	Low stage high-pressure safety switch (line voltage)			401265-1
J	RJ-45 Ethernet port	-	R	Low stage high-pressure safety switch (control voltage)			401264-1
K	Remote alarm interface	-	S	Condenser fan motor			801247-1
L	LN ₂ / CO ₂ back-up system interface	-	T	Condenser fan blade			220744
M	AC power connector	-	U	High stage condenser discharge temperature sensor			800169-3
N	Condenser	801249-1	Not Shown	Ambient temperature sensor			800169-1

8 Schematics

8.1 Electrical Schematic

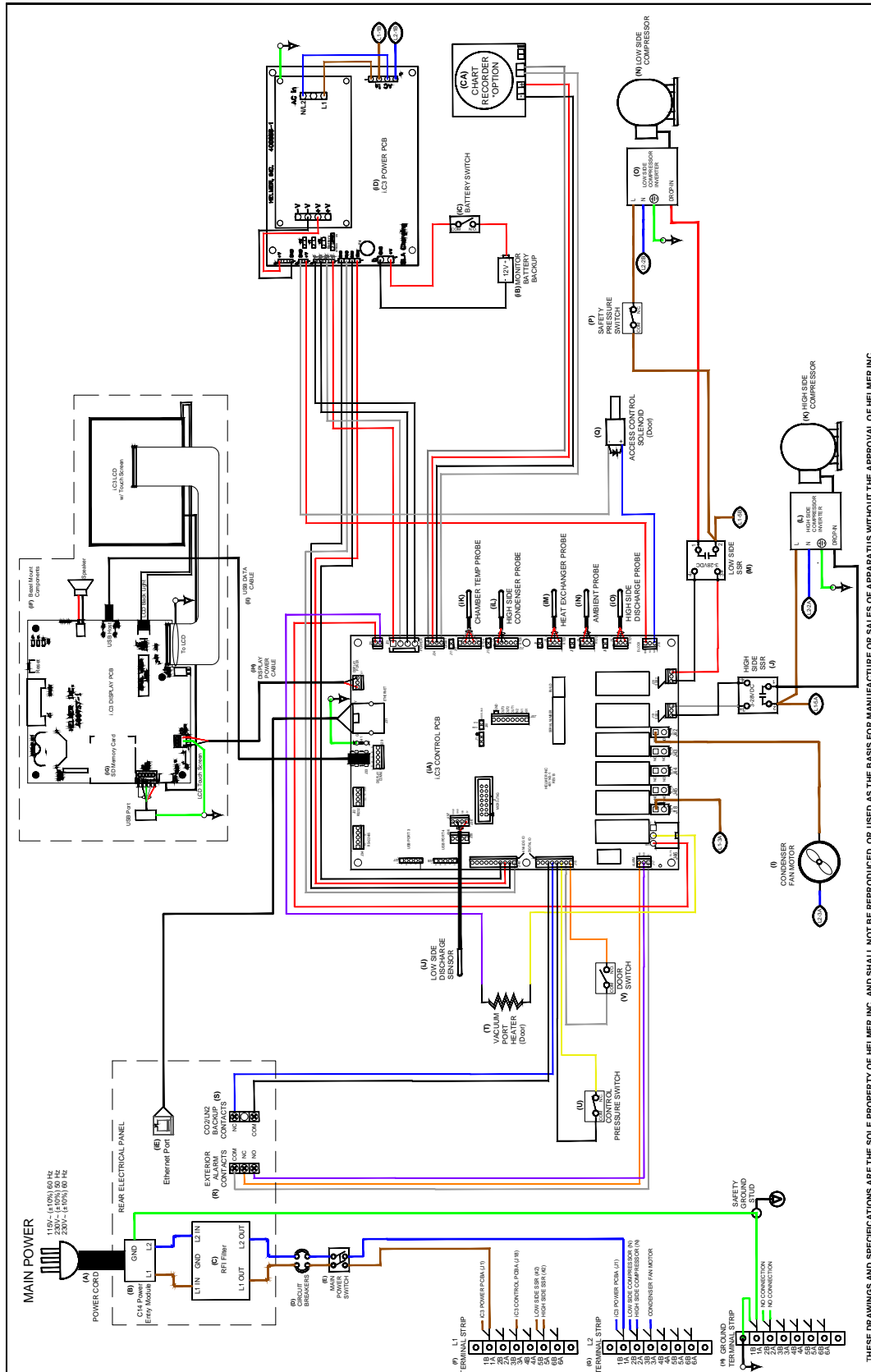

THESE DRAWINGS AND SPECIFICATIONS ARE THE SOLE PROPERTY OF HELMER INC. AND SHALL NOT BE REPRODUCED OR USED AS THE BASIS FOR MANUFACTURE OR SALES OF APPARATUS WITHOUT THE APPROVAL OF HELMER INC.

8.2 Refrigeration Schematic

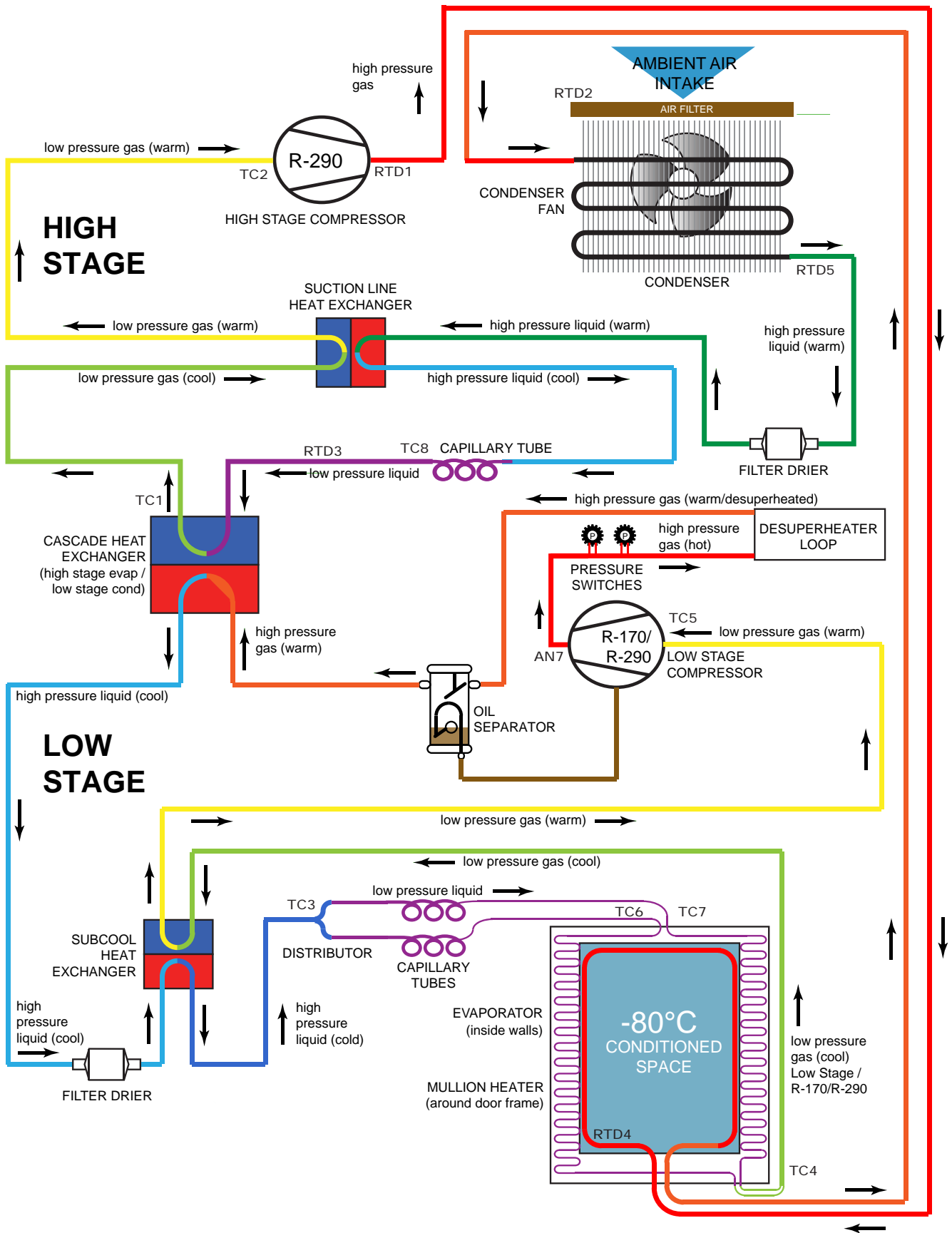

Appendix A: Warranty

Rel.i™ Product Warranty USA and Canada

For technical service needs, please contact Helmer at 800-743-5637 or www.helmerinc.com. Have the model and serial number available when calling.

Rapid Resolution

When a warranty issue arises it is our desire to respond quickly and appropriately. The service department at Helmer is there for you. Helmer will oversee the handling of your warranty service from start to finish. Therefore, Helmer must give advance authorization for all service calls and/or parts needs relating to a warranty issue. Any repeat service calls must also be authorized as well. This allows for proper diagnosis and action. Helmer will not be responsible for charges incurred for service calls made by third parties prior to authorization from Helmer. Helmer retains the right to replace any product in lieu of servicing it in the field.

Compressor

For the warranty period listed below, Helmer will supply the refrigeration compressor, if it is determined to be defective, at no charge, including freight. Helmer will not be liable for installation, refrigerant, or miscellaneous charges required to install the compressor beyond the first year of the warranty period.

- ◆ i.Series model compressor warranty period is five (5) years.

Parts

For a period of two (2) years, Helmer will supply at no charge, including freight, any part that fails due to defects in material or workmanship under normal use, with the exception of expendable items. Expendable items such as glass, filters, light bulbs, door gaskets, and monitoring system back-up battery are excluded from this warranty coverage. Inspection of defective parts by Helmer will be final in determining warranty status. Warranty procedures must be followed in all events.

Labor

For a period of two (2) years, Helmer will cover repair labor costs (including travel) and the cost of refrigerant and supplies necessary to perform authorized repairs. Repair service must be performed by an authorized Helmer service agency following the authorization process detailed above. Alternatively, your facility's staff may work with a Helmer technician to make repairs. Labor costs for repairs made by unauthorized service personnel, or without the assistance of a Helmer technician, will be the responsibility of the end user.

Additional Warranty Information

The time periods set forth above begin two (2) weeks after the original date of shipment from Helmer. Warranty procedures set forth above must be followed in all events.

THERE ARE NO WARRANTIES WHICH EXTEND BEYOND THE DESCRIPTION ON THE FACE HEREOF. THIS WARRANTY IS EXCLUSIVE AND IN LIEU OF ALL OTHER WARRANTIES, EXPRESS OR IMPLIED, INCLUDING WITHOUT LIMITATION ANY WARRANTY OF MERCHANTABILITY OR FITNESS FOR A PARTICULAR PURPOSE. NO WARRANTIES OF MERCHANTABILITY OR FITNESS FOR PARTICULAR PURPOSE SHALL APPLY.

THE LIABILITY, IF ANY, OF HELMER FOR DIRECT DAMAGES WHETHER ARISING FROM A BREACH OF ANY SALES AGREEMENT, BREACH OF WARRANTY, NEGLIGENCE, OR INDEMNITY, STRICT LIABILITY OR OTHER TORT, OR OTHERWISE WITH RESPECT TO THE GOODS OR ANY SERVICES IS LIMITED TO AN AMOUNT NOT TO EXCEED THE PRICE OF THE PARTICULAR GOODS OR SERVICES GIVING RISE TO THE LIABILITY. IN NO EVENT SHALL HELMER BE LIABLE FOR ANY INDIRECT, INCIDENTAL, CONSEQUENTIAL, OR SPECIAL DAMAGES, INCLUDING WITHOUT LIMITATION DAMAGES RELATED TO LOST REVENUES OR PROFITS, OR LOSS OF PRODUCTS.

This warranty does not cover damages caused in transit, during installation by accident, misuse, fire, flood, or acts of God. Further, this warranty will not be valid if Helmer determines that the failure was caused by a lack of performing recommended equipment maintenance (per Helmer manual) or by using the product in a manner other than for its intended use. Installation and calibration are not covered under this warranty agreement.

Outside of USA and Canada

Consult your local distributor for warranty information.

END OF MANUAL

Helmer Scientific

14400 Bergen Boulevard, Noblesville, IN 46060 USA
