

Refrigerator Service and Maintenance Manual

i.Series® and Horizon Series™ - Upright

Laboratory

i.Series

iLR113-GX, iLR120-GX, iLR125-GX,
iLR245-GX, iLR256-GX

Horizon Series

HLR113-GX, HLR120-GX, HLR125-GX,
HLR245-GX, HLR256-GX

Pharmacy

i.Series

iPR113-GX, iPR120-GX, iPR125-GX,
iPR245-GX, iPR256-GX

Horizon Series

HPR113-GX, HPR120-GX, HPR125-GX,
HPR245-GX, HPR256-GX

Blood Bank

i.Series

iBR113-GX, iBR120-GX, iBR125-GX,
iBR245-GX, iBR256-GX

Horizon Series

HBR113-GX, HBR120-GX, HBR125-GX,
HBR245-GX, HBR256-GX



Document History

Revision	Date	CO	Supersession	Revision Description
A	8 AUG 2019	14861	n/a	Initial release.
B	27 JAN 2020	15262	B supersedes A	<ul style="list-style-type: none">• Updated frequency for testing and replacing the monitoring system back-up battery.• Updated Troubleshooting table to include problem resulting from use of GFCI outlet and possible action.• Updated caution symbols throughout the document• Removed Compliance information as it can be found in the Operation Manual.
C	17 JAN 2022	16361	C supersedes B	<ul style="list-style-type: none">• Updated clearance information in Location Requirements section.• Corrected probe error codes in Alarm Indications table.• Added GFI/GFCI note to Placement and Leveling sections.• Updated PM schedule regarding replacement frequency of CR2032 battery.• Updated Remove/Install shelf instructions.• Updated Refrigerant Charge table.

* Date submitted for Change Order review. Actual release date may vary.

Document Updates

The document is furnished for information use only, is subject to change without notice and should not be construed as a commitment by Helmer Scientific. Helmer Scientific assumes no responsibility or liability for any errors or inaccuracies that may appear in the informational content contained in this material. For the purpose of clarity, Helmer Scientific considers only the most recent revision of this document to be valid.

Notices and Disclaimers

Confidential / Proprietary Notices

Use of any portion(s) of this document to copy, translate, disassemble or decompile, or create or attempt to create by reverse engineering or otherwise replicate the information from Helmer Scientific products is expressly prohibited.

Copyright and Trademark

Copyright © 2022 Helmer, Inc. Helmer®, i.Series®, i.C³®, Horizon Series™, and Rel.i™ are registered trademarks or trademarks of Helmer, Inc. in the United States of America. All other trademarks and registered trademarks are the property of their respective owners. Helmer, Inc., doing business as (DBA) Helmer Scientific and Helmer.

Disclaimer

This manual is intended as a guide to provide the operator with necessary instructions on the proper use and maintenance of certain Helmer Scientific products.

Any failure to follow the instructions as described could result in impaired product function, injury to the operator or others, or void applicable product warranties. Helmer Scientific accepts no responsibility for liability resulting from improper use or maintenance of its products.

The screenshots and component images appearing in this guide are provided for illustrative purposes only, and may vary slightly from the actual software screens and/or product components.

Contents

- 1 About This Manual 4**
 - 1.1 Intended Audience 4
 - 1.2 Model Reference 4
 - 1.3 Intended Use 4
 - 1.4 Safety Symbols and Precautions 4
 - 1.5 Avoiding Injury 5
 - 1.6 Model and Input Power 6
 - 1.7 Product Labels 6
- i.Series Information 7**
- 2 Installation and Configuration 7**
 - 2.1 Location Requirements 7
 - 2.2 Placement and Leveling 7
 - 2.3 Connect Backup Power 7
 - 2.4 Prepare for Monitoring 8
 - 2.5 Configure Storage 11
 - 2.6 Optional Adapter Kits for Medication Dispensing Locks 12
- 3 Controls 13**
 - 3.1 Home Screen and Screensaver 13
 - 3.2 Home Screen Functions 13
 - 3.3 Alarm Reference 13
 - 3.4 Settings 14
 - 3.5 Sensor Calibration 18
- 4 Maintenance 23**
 - 4.1 Alarm Tests 24
 - 4.2 Test and Replace Backup Batteries 26
 - 4.3 Check Probe Bottle (if installed) 27
 - 4.4 Display Board Battery 27
 - 4.5 Upgrade System Firmware 27
 - 4.6 Re-apply Silver Conductive Grease to Upper Door Hinge 27
 - 4.7 Clean the Refrigerator 28
- 5 Service 29**
 - 5.1 Refrigerant 29
 - 5.2 Remove / Replace Unit Cooler Cover 29
- 6 Troubleshooting 31**
 - 6.1 Access System Problems 31
 - 6.2 Chamber Temperature Problems 31
 - 6.3 Alarm Activation Problems 32
 - 6.4 Condensation Problems 32
- 7 i.Series Parts 33**
- 8 Schematics 36**
 - 8.1 iBR, iPR and iLR Models 36

Horizon Series Information. 38

9 Installation and Configuration 38

9.1 Location Requirements 38

9.2 Placement and Leveling 38

9.3 Connect Backup Power 38

9.4 Prepare for Monitoring 39

9.5 Configure Storage 42

9.6 Optional Adapter Kits for Medication Dispensing Locks 43

10 Controls. 44

10.1 Monitor and Control Interface 44

10.2 Alarm Reference 46

10.3 Settings 47

11 Maintenance 51

11.1 Alarm Tests 52

11.2 Test and Replace Backup Batteries 53

11.3 Check Probe Bottle (if installed) 54

11.4 Clean the Refrigerator 54

12 Service. 55

12.1 Refrigerant 55

12.2 Remove / Replace Unit Cooler Cover 55

13 Troubleshooting 56

13.1 Access System Problems 56

13.2 Chamber Temperature Problems 56

13.3 Alarm Activation Problems 57

13.4 Condensation Problems 57

14 Horizon Series Parts 58

15 Schematics 61

15.1 HBR, HLR and HPR Mode 61

15.2 HBR, HLR and HPR Models (without Access Control) 62

15.3 HBR, HLR and HPR Models (with Access Control) 63

Appendix A: Warranty 64

1 About This Manual

1.1 Intended Audience

This manual provides information on how to use i.Series® and Horizon Series™ upright laboratory, blood bank, and pharmacy refrigerators. It is intended for use by end users of the refrigerator and authorized service technicians.

1.2 Model Reference

Models are indicated by a distinguishing model number that corresponds to the series, type, number of doors, and capacity of the refrigerator. For example, “iLR113-GX” refers to an i.Series Laboratory Refrigerator with 1 door and a capacity of 13 cu ft.

1.3 Intended Use

Note

This equipment has been tested and found to comply with the limits for a Class A digital device, pursuant to part 15 of the FCC Rules. These limits are designed to provide reasonable protection against harmful interference when the equipment is operated in a commercial environment. This equipment generates, uses and can radiate radio frequency energy and, if not installed and used in accordance with the instruction manual, may cause harmful interference to radio communications. Operation of this equipment in a residential area is likely to cause harmful interference in which case the user will be required to correct the interference at his own expense.

Helmer refrigerators are intended for the storage of blood products and other medical and scientific products.

1.4 Safety Symbols and Precautions

Symbols found in this document

The following symbols are used in this manual to emphasize certain details for the user:



Task Indicates procedures which need to be followed.



Note Provides useful information regarding a procedure or operating technique when using Helmer Scientific products.

NOTICE Advises the user against initiating an action or creating a situation which could result in damage to equipment; person injury is unlikely.

Symbols found on the unit

The following symbols may be found on the refrigerator or refrigerator packaging:



Caution: Risk of damage to equipment or danger to operator



Warning: Crushing of hands / fingers



Caution: Hot surface



Warning: Flammable material



Caution: Shock / electrical hazard



Refer to documentation

1.5 Avoiding Injury



- Do not use mechanical devices or other means to accelerate the defrosting process, other than those recommended by the manufacturer.
- Do not damage the refrigerant circuit.

Review safety instructions before installing, using, or maintaining the equipment.

- ◆ Before moving unit, ensure door is closed and casters are unlocked and free of debris.
- ◆ Before moving unit, disconnect the AC power cord and secure the cord.
- ◆ Never physically restrict any moving component.
- ◆ Avoid removing electrical service panels and access panels unless so instructed.
- ◆ Keep hands away from pinch points when closing the door.
- ◆ Avoid sharp edges when working inside the electrical compartment and refrigeration compartment.
- ◆ Ensure products are stored at recommended temperatures determined by standards, literature, or good laboratory practices.
- ◆ Proceed with caution when adding and removing product from the refrigerator.
- ◆ Do not open multiple, loaded drawers at the same time.
- ◆ Use manufacturer supplied power cord only.
- ◆ Avoid risk of ignition by using only manufacturer supplied components and authorized personnel when servicing the unit.
- ◆ Using the equipment in a manner not specified by the manufacturer may impair the protection provided by the equipment.
- ◆ Ensure product is stored safely, in accordance with all applicable organizational, regulatory and legal requirements.
- ◆ The refrigerator is not considered to be a storage cabinet for flammable or hazardous materials.
- ◆ **REQUIRED:** Decontaminate parts prior to sending for service or repair. Contact Helmer or your distributor for decontamination instructions and a Return Authorization Number.

1.6 Model and Input Power

Note

Service information varies depending on the model and power requirements.

Table 1. Model and Input Power

Model	Voltage	Frequency	Current Draw
113	115V	60 Hz	2.3 A
	220-240V	50/60 Hz	1.12A
120	115V	60 Hz	2.8A
	220-240V	50/60 Hz	1.55A
125	115V	60 Hz	2.8A
	220-240V	50/60 Hz	1.55A
245	115V	60 Hz	4.3A
	220-240V	50/60 Hz	2.5A
256	115V	60 Hz	4.3A
	220-240V	50/60 Hz	2.5A

* Amperage values are subject to change. Refer to the product specification label on your unit for current values.

1.7 Product Labels

This information appears on the product specification label, located on the rear of the refrigerator below the electrical box. The model also appears on a label located in the chamber on the upper right side wall.

Note

Information contained in this specification label varies depending on the model and power requirements.

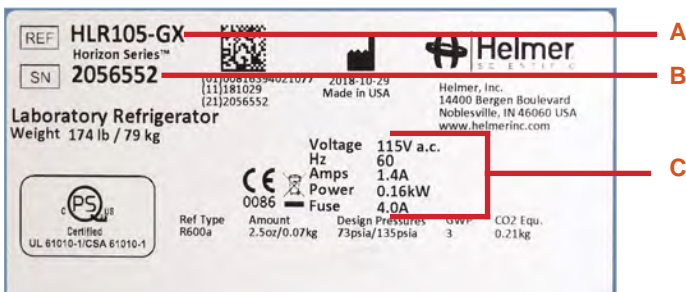

Label	Description
A	Model (REF)
B	Serial number
C	Power requirements

Sample Product Specification label.

i.Series Information

2 Installation and Configuration

2.1 Location Requirements



Keep all ventilation openings in the enclosure or, in the structure for building-in, clear of obstruction.

- ◆ Has a grounded outlet meeting the electrical requirements listed on the product specification label.
- ◆ Is clear of direct sunlight, high temperature sources, and heating and air conditioning vents.
- ◆ Has a minimum 8" (203 mm) above and minimum 3" (76 mm) behind the unit for proper ventilation, clearance and feature access.
- ◆ Meets specified limits specified for ambient temperature and relative humidity as stated in the Product Specifications section of the Operation manual.

2.2 Placement and Leveling

NOTICE

- Helmer does not recommend operating this unit on a GFI/GFCI outlet.
 - The evaporation tray located on the rear of the refrigerator may be hot. Do not use the tray as a handle.
 - To prevent tipping, ensure the casters are unlocked, leveling feet (if installed) are lifted, and the doors are closed before moving the refrigerator.
 - To avoid damaging refrigerant tubing or risking refrigerant leak, use caution when moving or operating the unit.
1. Ensure door is secured and casters (if installed) are unlocked.
 2. Roll refrigerator into place and lock casters.
 3. Ensure refrigerator is level.

2.3 Connect Backup Power

The monitoring system and chart recorder each have a backup battery system enabling a period of continuous operation if power is lost.

Battery life varies by manufacturer, voltage level remaining as well as whether optional Access Control is installed. Providing full power is available, Access Control is not installed and no battery-related alarms are active, backup power for the monitoring system is available for up to 20 hours (the Low Battery alarm will activate after approximately 18 hours of battery use). Providing full power is available, backup power for the monitoring system and optional Access Control system is available for at least 2 hours.

NOTICE

Before installing or replacing batteries, switch the AC power switch and backup battery switch OFF. Disconnect the refrigerator from AC power.

Notes

- The optional Access Control system uses the monitoring system backup battery for backup power in the event of power failure.
- The monitoring system will start on backup battery power alone. If the refrigerator was not previously connected to AC power and the backup battery is switched on, the monitoring system will begin running on backup battery power.
- If AC power is lost, the monitoring system will automatically disable some features to prolong backup battery power. Data collection will continue until backup battery power is depleted.

The monitoring system backup battery is located on top of the refrigerator. A removable panel provides access to the backup battery for 113 models. An optional top panel may be installed on all other models, and must be removed to access the backup battery.



Monitoring system backup battery.

2.4 Prepare for Monitoring

The backup battery switch is switched OFF for shipping. Switch the backup battery switch ON to provide the monitoring system and optional Access Control system with backup power in the event of an AC power failure.

Temperature Probes

Notes

- Temperature probes are fragile; handle with care.
- 13cf models do not have a secondary probe.
- Remote probes may also be introduced through the existing port and immersed in existing probe bottles.
- Solid ballast (if installed) should be placed in the bracket in a horizontal position.

The number and location of probes varies by model. External probes may be introduced through the existing top port or through a side access port which is available in some models.

A solid ballast or probe bottle and container of glycerin have been provided with this unit. When using the probe bottle, mix the glycerin with water to create a solution which simulates the product stored in the refrigerator. The product simulation solution temperature reflects the product's temperature during normal operation.

The probe bottle should contain 4 oz. (120 mL) of product simulation solution at a 10:1 ratio of water to glycerin.



Primary monitor probe



Secondary probe



Solid ballast (optional)

Fill Probe Bottle (if included)

1. Remove probe(s) from bottle and remove bottle from bracket.
2. Remove cap and fill with 4 oz. (120 mL) of product simulation solution.
3. Install cap and place bottle in bracket.
4. Replace probe(s), immersing at least 2" (50 mm) in solution.

Install Additional Probe Through Top Port

1. Peel back putty to expose port.
2. Insert probe through port into chamber.
3. Insert probe into bottle immersing at least 2" (50 mm), or insert in ballast and secure with thumb screw.
4. Replace putty, ensuring a tight seal.

Chart Recorder (if included)

Note

- For complete information, refer to the Temperature Chart Recorder Operation and Service Manual.
- If the chart recorder has been operating on battery power, the battery should be replaced to ensure the backup source has proper charge.

The chart recorder has a backup battery system, enabling a period of continuous operation if power is lost. Battery life varies by manufacturer as well as voltage level remaining. Providing full power is available, backup power for the temperature chart recorder is available for up to 14 hours.

Set up and Operation

Access chart recorder by pressing and releasing (i.Series except 113 models) or pulling door open (113 models).



Chart Recorder



Chart Recorder (13cf models)

Install Battery

Connect leads to battery to provide backup power to chart recorder.

Install / Replace Chart Paper

Notes

- For an accurate temperature reading, ensure the current time is aligned with the time line groove when the chart knob is fully tightened.
- Contact Helmer Customer Service or your distributor to reorder chart paper.

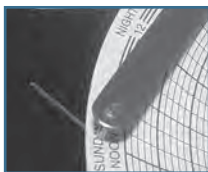

Chart recorder stylus and time line groove

1. Press and hold **C** button. When stylus begins to move left, release button. LED flashes.
2. When stylus stops moving, remove chart knob then move knob up and away.
3. Place chart paper on chart recorder.
4. Gently lift stylus and rotate paper so current time line corresponds to time line groove.
5. Hold chart paper in place while making sure chart knob is fully tightened. *(Failure to fully tighten the knob can result in paper slipping and losing time.)*
6. Press and hold **C** button. When stylus begins to move right, release button.
7. Confirm stylus is marking on paper and stops at correct temperature.
8. Calibrate chart recorder to match primary temperature if needed and close recorder door.

External Monitoring Devices

The remote alarm interface is a relay switch with three terminals:

- ◆ Common (COM)
- ◆ Normally Open (NO)
- ◆ Normally Closed (NC)

Terminals are dry contacts and do not supply voltage. Interface circuit is either normally open or normally closed, depending on terminals used.

Requirements for your alarm system determine which alarm wires must connect to terminals.

NOTICE

- The interface on the remote alarm monitoring system is intended for connection to the end user's central alarm system(s) that uses normally-open or normally-closed dry contacts.
- If an external power supply exceeding 33 V (AC) RMS or 30 V (DC) is connected to the remote alarm monitoring system's circuit, the remote alarm will not function properly and may cause damage to the control board or result in injury to the user.

The terminals on the remote alarm interface have the following maximum load capacity:

- ◆ 115V or 230V: 1 A at 33 V (AC) RMS or 30 V (DC)



Connect to Remote Alarm Interface

1. Locate remote alarm terminals in back of unit on left side of electrical panel.
2. Using a #2 Phillips screwdriver, connect remote alarm wires to appropriate terminals, according to requirements for your alarm system.
3. Use cable tie to relieve strain on alarm wires (as necessary).

2.5 Configure Storage

NOTICE

- Before moving drawers or shelves, ensure they are completely empty for safe lifting.
- Maximum drawer or shelf load is 100 lbs (46 kg).

Note

Before moving storage components, protect stored items in refrigerator from extended exposure to adverse temperature.

Product Loading Guidelines

When loading your refrigerator, take care to observe the following guidelines:

- ◆ Never load refrigerator beyond capacity.
- ◆ Always store items within shelves or drawers.
- ◆ Temperature uniformity is maintained by air circulation, which could be impeded if unit is overfilled, particularly at top or back. Ensure a minimum of 2" (50 mm) clearance is provided below fan.

Note

Products stacked against back wall may obstruct air flow and affect performance of unit.

Drawers

Remove Drawer

1. Pull drawer out until it stops.
2. On right rail, locate release tab and press downward.
3. While holding right release tab downward, locate release tab on left rail and press upward.
4. Pull drawer free of slides.

Install Drawer

1. Align end guides on drawer with slides.
2. Gently push drawer into chamber until it stops.
3. Pull drawer out until it stops; check for smooth operation.

Move Drawer Slides

1. Using a screwdriver, remove bracket retainers.
2. Tap brackets upward to disengage standards.
3. Remove slides from standards.
4. Insert slides into standard at appropriate height.
5. Tap brackets downward to engage standards.
6. Using a screwdriver, install bracket retainers.

Shelves

Remove Shelf

1. With one hand, lift front edge of shelf from front brackets.
2. With other hand, reach under shelf and bump rear edge of shelf upward to disengage rear brackets.

Install Shelf

1. Insert shelf into chamber, placing it on the rear brackets and with the front edge of the shelf angled upward approximately 8 inches.
2. Lower the front edge and gently bump rear edge of shelf downward to engage with brackets.
3. Pulling shelf forward gently, shelf should not disengage from rear brackets.

Move Shelf Brackets

1. Using a screwdriver, remove bracket retainers.
2. Tap brackets upward to disengage standards.
3. Remove brackets from standards.
4. Insert brackets into standard at appropriate height.
5. Tap brackets downward to engage standards.
6. Using a screwdriver, install bracket retainers.

2.6 Optional Adapter Kits for Medication Dispensing Locks

Contact Helmer Technical Service or your distributor for service documentation pertaining to medication dispensing locks.

3 Controls

i.Series models are equipped with the i.C³ monitoring and control system. The i.C³ system combines temperature control and monitoring into a single user interface.

Note

Please refer to the i.C³ User Guide for complete information regarding the i.C³ User Interface.

3.1 Home Screen and Screensaver

The Home Screen is the default screen and is displayed when:

- ◆ The Home icon is touched from any other screen.
- ◆ There is no interaction for two minutes on any screen other than those used to enter a password.



Home Screen

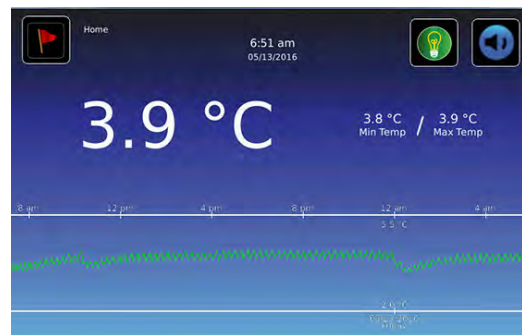

Screensaver

3.2 Home Screen Functions

Note

Refer to the i.C³ User Guide for options available on all i.C³ screens.

- ◆ View current interior cabinet temperature readings
- ◆ View the current system time and date
- ◆ Access any of the five home screen applications (touch **i.C³ APPS** for additional applications)
- ◆ View information about current alarm events
- ◆ View whether the monitoring system is running on battery power
- ◆ Mute audible alarms
- ◆ Turn the chamber light on and off (if applicable)
- ◆ View a graph of the chamber temperature
- ◆ View unit ID
- ◆ Shortcut to Event Log

3.3 Alarm Reference

If an alarm condition is met, an alarm activates. Some alarms are visual only; others are visual and audible. Some alarms are sent through the remote alarm interface. The table below indicates if an alarm is audible (A), visual (V), or sent through the remote alarm interface (R).

Table 2. i.Series Alarm Reference

Alarm	Alarm Type	Alarm	Alarm Type
High Temperature	A, V, R	Low Battery	V
Low Temperature	A, V, R	No Battery	A, V, R
Compressor Temperature	A, V, R	Probe Failure	A, V, R
Door Open (Time)	A, V, R	Communication Failure	A, V, R
Power Failure	A, V, R		



3.4 Settings



Through the i.C³ monitoring and control system, current settings may be viewed and changed. To view settings, touch **i.C³ APPS, Settings**. Use a touch-drag motion to scroll up or down to select the desired setting.

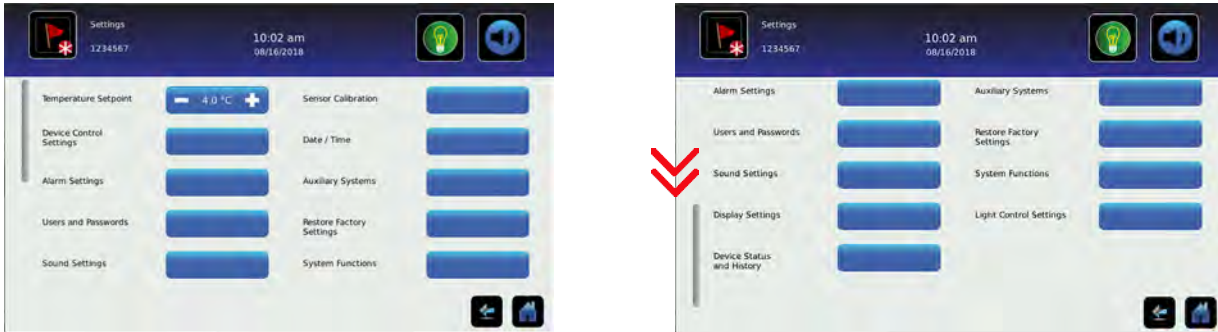

Settings screens

i Notes

- If the Settings screen is password protected, enter the appropriate password. If viewing settings for the first time, enter the factory default password of “1234”.
- Default values for general settings, alarm settings, and display settings are available in the i.C³ User Guide.
- Changing temperature settings affects operation of the refrigerator. Do not change settings unless instructed in product documentation or by Helmer Technical Service.

The i.C³ temperature monitor and controller is programmed at the factory. To change a setting, first enter the Settings screen, then select the setting. The method for accessing the Settings mode for each setting varies.

Device Control Settings

Device control settings are programmed at the factory. Setpoints can be viewed and changed through the i.C³ monitoring and control system. To view temperature setpoints, touch **i.C³ APPS, Settings, Device Control Settings**.



Device Control Settings screen.

Table 3. Setpoints

Setting	Initial Factory Value
Temperature Setpoint	4.0 °C
Upper Rail	0.7 °C
Lower Rail	-0.7 °C
Delay on Startup	1 minute
Speed During Probe Error	50%



Temperature Setpoint

The setpoint is the temperature at which the refrigerator operates. The factory default setting for the primary monitor probe is 4.0°C for iLR and iBR models, or 5.0 °C for iPR models.

Notes

- If the Settings screen is password protected enter the appropriate password. If viewing settings for the first time, enter the factory default password of “1234”.
- The Temperature Setpoint can be adjusted through the main Settings screen and Device Control Settings screen.
- Change the setpoint if your organization requires a chamber temperature other than 4.0 °C for iLR and iBR models, or 5.0 °C for iPR models.

Change Temperature Setpoint

1. Touch **i.C³ APPS, Settings**.
2. Enter Settings password.
3. Touch minus (–) or plus (+) on **Temperature Setpoint** spin box to select desired value.

Upper Rail

Upper rail is the maximum control temperature at which the compressor will turn on.

Lower Rail

Lower rail is the minimum control temperature at which the compressor will turn off.

Delay on Start-Up

Compressor startup is delayed to allow the i.C³ monitoring and control system to start first.

Speed During Probe Error

The compressor will run as a percent of maximum if both the monitor and control probe fail.

NOTICE

Upper Rail, Lower Rail, Delay on Start-up and Speed During Probe Error are factory-preset and should not be changed unless directed by Helmer Technical Service.

User Configurable Alarm Settings

The following alarm settings may be changed by the operator. The setpoint for temperature alarms may be changed (where applicable), as well as the time delay between when the alarm condition commences and when the visual and audible alarms are initiated.

Table 4. User Configurable Alarms

Alarm	Description	Default Value	Default Time Delay
Primary Monitor Probe High Temp	High temperature at which alarm condition occurs	5.5 °C (<i>iBR and iLR models</i>)	0 minutes
		6.5 °C (<i>iPR models</i>)	
Primary Monitor Probe Low Temp	Low temperature at which alarm condition occurs	1.5 °C (<i>iBR models</i>)	0 minutes
		2.0 °C (<i>iLR and iPR models</i>)	
Compressor High Temp	High temperature at which alarm condition occurs	50 °C	0 minutes
Power Failure	Time after power failure occurs until alarm sounds	-	1 minute
Probe Failure	Time after probe failure occurs until alarm sounds	-	0 minutes
Door Open (Time)	Time door remains open until alarm sounds	-	3 minutes

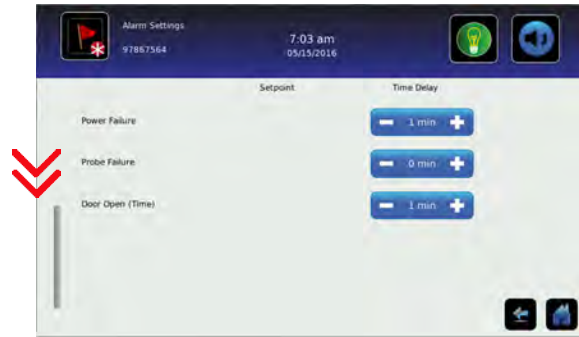
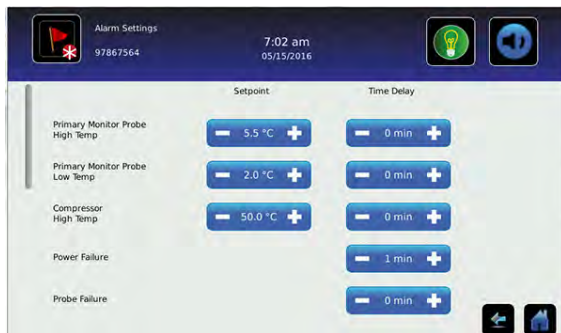

Alarm setting screens

Change an Alarm Setting

1. Touch **i.C³ APPS, Settings**.
2. Enter Settings password (default password is "1234").
3. Scroll down and touch **Alarm Settings**.
4. Touch minus (-) or plus (+) on spin box corresponding to alarm setting to be changed.
5. Touch **Home** to exit Alarm Settings screen.

i.Series

Non-Configurable Alarms

The following alarms indicate operational conditions which require the attention of the operator or a qualified service technician.

Table 5. Non-Configurable Alarm

Alarm	Description
Low Battery	Monitoring system rechargeable battery voltage is low
Drive Space Low	<ul style="list-style-type: none"> Triggered if SD card containing downloadable historical data is approaching capacity New data will continue to be saved for up to 3 more months Data can be downloaded, but doing so will not free up capacity (SD card replacement recommended)
Drive Space Full	<ul style="list-style-type: none"> Triggered if the SD card containing downloadable historical data has reached its capacity No new data will be saved Data can be downloaded, but doing so will not free up capacity (SD card replacement required)
Communication Failure	<p>Communication Failure 1</p> <ul style="list-style-type: none"> Triggered if communication is lost between i.C³ display board and control board. Unit will continue to run with previously saved settings Screen will not display temperature changes or alarm conditions i.C³ system will continue to reset until connection is re-established <p>Communication Failure 2</p> <ul style="list-style-type: none"> Triggered if communication is lost between i.C³ display board and internal system memory Unit will continue to run with previously saved settings <p>Communication Failure 3</p> <ul style="list-style-type: none"> Triggered if the database is corrupted The database is archived and a new database is automatically created Unit will continue to run with previously saved settings
Inverter Communication Failure	<ul style="list-style-type: none"> Triggered if there is a problem with the refrigeration system <p>Contact Helmer Technical Service for more information</p>

3.5 Sensor Calibration



Sensor calibration values are programmed at the factory. Calibration values can be viewed and changed through the i.C³ monitoring and control system. To view calibration settings, touch **i.C³ APPS**, **Settings**, and select **Sensor Calibration**.

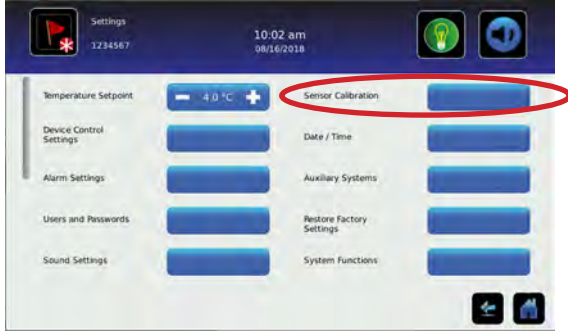

Settings Screen

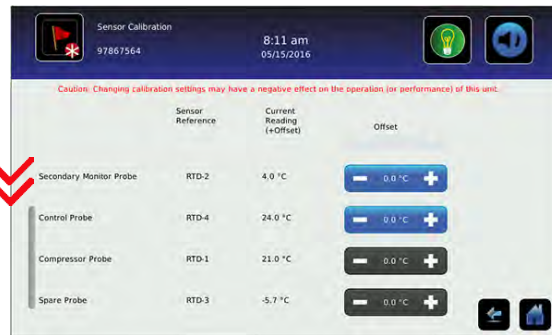

Sensor Calibration screens

Notes

- If the Settings screen is password protected enter appropriate password. If viewing settings for the first time, enter factory default password of “1234”.
- Offset values are adjusted to the tenth of a degree (0.1).
- After one hour of no interaction, the Home screen or Temperature Graph screensaver (if enabled) is displayed.
- The Compressor Probe offset is factory-preset and should not be changed unless directed by Helmer Technical Service.

View Sensor Calibration Values

1. Touch the **Settings** icon.
2. Enter Settings password.
3. Touch **Sensor Calibration**. Sensor offset values and their current temperature readings are displayed.
4. Touch **Home** to return to Home screen.

i.Series

Primary and Secondary Monitor Probes

Verify primary monitor probe is reading chamber temperature correctly by comparing the probe reading to the temperature measured by a calibrated reference thermometer. If the probe is not reading correctly, change the value displayed on the monitor.

Notes

- Ensure the product simulation bottle is full of solution.
- 13cf models do not have a secondary probe.
- The probe in the bottle or ballast is connected to the monitoring system and senses chamber temperature. This probe activates the temperature alarms but does not affect temperature control.
- For units with a solid ballast, Helmer recommends using putty to seal the probe hole when using a thermocouple wire to calibrate.

Calibrate Primary Monitor Probe *(probe bottle installed)*

- 1 Remove Primary Monitor Probe from probe bottle.
- 2 Unscrew cap from bottle.
- 3 Attach calibrated independent reference thermometer traceable per national standards to Primary Monitor Probe, and place them in bottle. Probe and thermometer should be immersed at least 2" (50 mm).
- 4 Close door and allow chamber temperature to stabilize.
- 5 Observe and note thermometer temperature. If independent thermometer corresponds to displayed temperature, proceed to **Step 11**.
- 6 Subtract displayed temperature reading from independent probe reading to determine offset value adjustment.
- 7 Touch, **i.C³ APPS, Settings**
- 8 Enter Settings password (default password is "1234").
- 9 Touch **Sensor Calibration**.
- 10 Touch minus (-) or plus (+) on corresponding spin box to increase or decrease value by value calculated in **Step 6**. The message "New Setting Saved" appears next to spin box.
- 11 Remove thermometer from probe.
- 12 Replace bottle cap, ensuring a tight fit.
- 13 Place probe in bottle, immersing at least 2" (50 mm).

Calibrate Primary Monitor Probe *(solid ballast installed)*

- 1 Ensure Primary Monitor Probe is securely installed in ballast.
- 2 Place calibrated independent reference thermometer in a remaining probe hole in ballast and tighten thumb screw to secure. This may involve temporarily removing additional probe to provide opening for independent reference thermometer.
- 3 Place reference thermometer in available probe hole. Tighten thumb screw until thermometer is secure (Take care not to over-tighten the thumb screw).
- 4 Close the door and allow the chamber temperature to stabilize.
- 5 Observe and note thermometer temperature. If independent thermometer corresponds to displayed temperature, proceed to **Step 11**.
- 6 Subtract displayed temperature reading from independent probe reading to determine offset value adjustment.
- 7 Touch, **i.C³ APPS, Settings**
- 8 Enter Settings password (default password is "1234").
- 9 Touch **Sensor Calibration**.
- 10 Touch minus (-) or plus (+) on corresponding spin box to increase or decrease value by value calculated in **Step 6**. The message "New Setting Saved" appears next to spin box.
- 11 Loosen thumb screw and remove calibrated independent reference thermometer from ballast.
- 12 Replace any additional probe that may have been removed previously, and tighten thumb screw ensuring a snug fit.
- 13 Replace any removed putty.

 **Calibrate Secondary Monitor Probe** *(probe bottle installed)*

- 1 Remove Secondary Monitor Probe from probe bottle.
- 2 Unscrew cap from bottle.
- 3 Attach calibrated independent reference thermometer traceable per national standards to Secondary Monitor Probe, and place them in bottle. Probe and thermometer should be immersed at least 2" (50 mm).
- 4 Close door and allow chamber temperature to stabilize.
- 5 Observe and note thermometer temperature. If independent thermometer corresponds to displayed temperature, proceed to **Step 11**.
- 6 Subtract displayed temperature reading from independent probe reading to determine offset value adjustment.
- 7 Touch, **i.C³ APPS, Settings**
- 8 Enter Settings password (default password is "1234").
- 9 Touch **Sensor Calibration**.
- 10 Touch minus (-) or plus (+) on corresponding spin box to increase or decrease value by value calculated in **Step 6**. The message "New Setting Saved" appears next to spin box.
- 11 Remove thermometer from probe.
- 12 Replace bottle cap, ensuring a tight fit.
- 13 Place probe in bottle, immersing at least 2" (50 mm).

 **Calibrate Secondary Monitor Probe** *(solid ballast installed)*

- 1 Ensure Secondary Monitor Probe is securely installed in ballast.
- 2 Place calibrated independent reference thermometer in a remaining probe hole in ballast and tighten thumb screw to secure. This may involve temporarily removing additional probe to provide opening for independent reference thermometer.
- 3 Place reference thermometer in available probe hole. Tighten thumb screw until thermometer is secure (Take care not to over-tighten the thumb screw).
- 4 Close the door and allow the chamber temperature to stabilize.
- 5 Observe and note thermometer temperature. If independent thermometer corresponds to displayed temperature, proceed to **Step 11**.
- 6 Subtract displayed temperature reading from independent probe reading to determine offset value adjustment.
- 7 Touch, **i.C³ APPS, Settings**
- 8 Enter Settings password (default password is "1234").
- 9 Touch **Sensor Calibration**.
- 10 Touch minus (-) or plus (+) on corresponding spin box to increase or decrease value by value calculated in **Step 6**. The message "New Setting Saved" appears next to spin box.
- 11 Loosen thumb screw and remove calibrated independent reference thermometer from ballast.
- 12 Replace any additional probe that may have been removed previously, and tighten thumb screw ensuring a snug fit.
- 13 Replace any removed putty.

Control Probe

The temperature controller senses unit cooler temperature through the control probe in the unit cooler. The unit cooler temperature typically varies from the chamber temperature, so an offset value is used by the control system to compensate for the difference. Chamber temperature will be controlled as required to match the temperature set point based on the control probe reading.

 **Determine Control Probe Offset**

NOTICE

- Control Probe Offset is factory-preset and should not be changed. Contact Helmer Technical Service for instructions regarding changing the Control Sensor Offset.
- Monitor temperature must be verified and accurate prior to adjusting the Control Sensor Offset.

1. View and record Temperature Setpoint.
2. Allow unit to run with calibrated monitor temperature for several compressor cycles, and record average monitor temperature.
3. View and record current Control Offset value.
4. Subtract Temperature Setpoint from average monitor temperature and record difference.
5. Add current Control Offset value to recorded difference determined in previous step to establish new Control Offset value.

Example 1	Example 2
Temperature setpoint is 4.0	Temperature setpoint is 4.0
Average monitor temperature is 5.2	Average monitor temperature is 2.8
Current Control Offset is 0.3	Current Control Offset is 0.3
Subtract: $5.2 - 4.0 = 1.2$ (difference between average temperature and setpoint)	Subtract: $2.8 - 4.0 = -1.2$ (difference between average temperature and setpoint)
Add: $0.3 + 1.2 = 1.5$ (new control offset value)	Add: $0.3 + (-1.2) = -0.9$ (new control offset value)

 **Enter New Offset Value:**

1. Touch **i.C³ APPS, Settings**.
2. Enter Settings password (default password is "1234").
3. Touch **Sensor Calibration**.
4. Touch minus (-) or plus (+) on **Control Probe Offset** spin box.
 - ◆ Raise offset value to lower chamber temperature; lower offset value to raise chamber temperature.
5. Touch **Home** to return to home screen.

Compressor Probe

The compressor temperature probe has been factory-calibrated. Changing the calibration setting is not typically necessary and should not be performed unless directed by Helmer Technical Service.

Factory Default Settings

Settings listed below may be simultaneously returned to factory default values.

Note

The factory default settings may not be the same as the settings that were factory-calibrated before the refrigerator was shipped.

Table 6. Default Settings

Setting	Restored Value
Home Screen Application Icons	i.C ³ APPS, Settings, Temperature Graph, Temperature Alarm Test, Information Logs
Display Brightness	3 (brightest)
Password (for Settings screen)	1234
Sounds	On
Alarm Volume	9
Alarm Tone	3
Temperature Calibration Values	Not affected (values previously entered during setup)
Unit ID	Not affected (previously selected during setup)
Date Format	MM/DD/YY
Day	Not affected (maintained in real-time clock)
Month	
Year	
Time Format	12-hour
Minute	Not affected (maintained in real-time clock)
Hour	
AM/PM	
Language	Not affected (Language previously selected during setup)
Temperature Units	°C
Password Protection (for Settings screen)	On
Temperature Graph Screensaver	On
Access Control (optional) as Home Page	On (if installed)
Light Off Delay (on/off)	On
Light Off Delay	5 minutes
High Temperature Alarm Setpoint	5.5 °C (iBR and iLR models); 6.5 °C (iPR models)
High Temperature Alarm Time Delay	0 minutes
Low Temperature Alarm Setpoint	1.5 °C (iBR models); 2.0 °C (iLR and iPR models)
Low Temperature Alarm Time Delay	0 minutes
Power Failure Alarm Time Delay	1 minute
Probe Failure Alarm Time Delay	0 minutes
Door Open (Time) Alarm Time Delay	3 minutes
Compressor Temperature Alarm Setpoint	50.0 °C
Compressor Temperature Alarm Time Delay	1 minute
Chamber Setpoint	4.0 °C (iBR and iLR models); 5.0 °C (iPR models)
Upper Rail	0.7 °C
Lower Rail	-0.7 °C
Delay on Start-Up	2 minutes
Speed During Probe Error	50%

Restore Settings:

1. Touch **Settings** icon.
2. Scroll down and touch **Restore Factory Settings** button. The Restore Factory Settings confirmation box appears.
3. Touch to restore factory settings or to maintain current settings and clear message.



4 Maintenance

Maintenance tasks should be completed according to the schedule below. Refer to the i.C³ User Guide for more detail on completing various tasks.

NOTICE

Maintenance should only be performed by trained refrigeration technicians.

Notes

- The preventive maintenance schedule provides recommended minimum requirements. Regulations or physical conditions at your organization may require maintenance items be performed more frequently, or only by designated service personnel.
- Before performing maintenance, protect items in refrigerator from extended exposure to adverse temperature.
- Allow refrigerator temperature to stabilize at setpoint after performing service or after extended door opening.

Table 9. i.Series Preventive Maintenance Schedule

Task	Frequency			
	1 year	2 years	5 years	As Needed
Test the high temperature <i>(over maximum temperature limit)</i> and low temperature <i>(below minimum temperature limit)</i> alarms <i>(as required by your organization's protocols)</i> .				✓
Test the power failure alarm <i>(as required by your organization's protocols)</i> .				✓
Test the door alarm <i>(as required by your organization's protocols)</i> .				✓
Verify the temperature calibration on the monitor and change it if necessary.	✓			
Replace monitoring system backup battery.		✓		
Examine probe bottle(s) and clean or replace if necessary.	✓			
Check the solution level in the probe bottle(s). Refill or replace if necessary.				✓
Check the chamber lights and replace if necessary.				✓
Replace Display Board CR2032 battery.				✓
Re-apply silver conductive grease to upper door hinge.			✓	
Clean the door gaskets, interior, and exterior of the refrigerator.				✓
Clean the condenser grill.				✓
Models with chart recorders				✓
Check the backup battery for the chart recorder after an extended power failure and change it if necessary, or change the battery if it has been in service for one year. Refer to the Temperature Chart Recorder Operation and Service Manual.				✓

NOTICE

Clean the condenser grill regularly. Dust accumulation on the condenser coil will vary based on the environment. Some environments require quarterly cleaning.

Notes

- During a power failure the backup battery provides power to the monitoring system, power failure alarm, and optional Access Control. If the backup battery is not functioning, the power failure alarm will not be activated and the battery should be replaced.
- During a power failure, the backup battery continues to provide power to the optional Access Control lock (if equipped). If the backup battery is not functioning, the optional Access Control lock will not secure the door.

i.Series

4.1 Alarm Tests

Test alarms to ensure they are working correctly. The refrigerator has alarms for chamber temperature, compressor temperature, power failure, probe failure, and door open (time).

Automatic Chamber Temperature Alarm Test



Temperature Alarm Test screen

Notes

- Test can be aborted by touching **Cancel Test**.
- Test is only applicable to the primary monitor probe.
- Test takes less than five minutes.
- If the temperature alarm test does not complete successfully, restart the i.C3 monitoring system.

When performing an automatic temperature alarm test, the Peltier device heats or cools the primary monitor probe until the high or low alarm setpoint is reached. An event is added to the Event Log to indicate a temperature alarm was activated. The Alarm Test icon is displayed on the Temperature Graph to indicate the temperature alarm was test-induced.

Test the Low Alarm:

1. Identify current setting for low alarm setpoint.
2. Touch **i.C3 APPS, Temperature Alarm Test**.
3. Touch **Low Alarm Test**.
4. “Peltier Test Probe Cooling” message appears.
5. When displayed temperature reaches alarm setpoint, an alarm is activated.
6. When completed, “Test Complete” appears.
7. Touch **i.C3 APPS, Information Logs, Event Log**. Touch event to view event details.
8. Observe temperature at time of low temperature alarm event. Compare this to the alarm setpoint.



Test the High Alarm:

1. Identify current setting for high alarm setpoint.
2. Touch **i.C3 APPS, Temperature Alarm Test**.
3. Touch **High Alarm Test**.
4. “Peltier Test Probe Warming” message appears.
5. When displayed temperature reaches alarm setpoint, temperature reading turns red.
6. When completed, “Test Complete” appears.
7. Touch **i.C3 APPS, Information Logs, Event Log**. Touch event to view event details.
8. Observe temperature at time of high temperature alarm event. Compare this to the alarm setpoint.



Cancel the Test:

1. Touch **Cancel Test** icon to end alarm test. “Test Stopped” is displayed in Test Status section of display.

Note

When cancelling an automatic test, the message indicating the test is in progress clears immediately. If a setpoint was reached before the test was cancelled, the alarm activates and clears as described previously.

Manual Chamber Alarm Test

NOTICE

- Perform the low alarm test before the high alarm test to control the temperature more closely and complete the testing more quickly.
- Before testing alarms, protect items in the unit from extended exposure to adverse temperature.
- Temperature probes are fragile; handle with care.

Test the Low Alarm:

1. Identify setting for low alarm setpoint.
2. Remove primary monitor probe from bottle or ballast.
3. Immerse probe in glass filled with water that is approximately 4 °C.
4. Slowly add crushed ice to lower temperature.
5. When temperature reaches the low alarm setting, an alarm will activate.

Test the High Alarm:

1. Identify setting for high alarm setpoint.
2. Immerse probe in glass filled with water that is approximately 4 °C.
3. Slowly add warm water to raise temperature.
4. When temperature reaches the high alarm setting, an alarm will activate.
5. Remove probe from warm water.
6. Place primary monitor probe in probe bottle, immersing it at least 2" (50 mm), or place in ballast and secure with thumbscrew taking care not to overtighten.

Power Failure Alarm Test

Note

During a power failure, the power failure alarm sounds and the battery provides power to the monitoring system and optional Access Control lock.

1. Change Power Failure delay setting to 0 minutes by touching **Home, Settings**
2. Enter Settings password (default password is "1234").
3. Touch **Alarm Settings**, then touch **(+)** or **(-)** on Power Failure spin box to change value to 0.
4. Switch AC power switch OFF. Power failure alarm will activate immediately.
5. Switch AC power switch ON. Power failure alarm will clear and audible alarm will cease.
6. Change Power Failure time delay to original setting.

Door Open Alarm Test

1. Change Door Open (Time) delay setting to 0 minutes by touching **Home, Settings**,
2. Enter Settings password (default password is "1234").
1. Touch **Alarm Settings**, then touch **(+)** or **(-)** on Door Open (Time) spin box to change value to 0.
2. Open door. Alarm will activate immediately.
3. Close door. Alarm will clear, and audible alarm will cease.
4. Change Door Open (Time) setting to original setting.

4.2 Test and Replace Backup Batteries

i.C³ Monitoring System Backup Battery

On all i.C³ screens, the Battery icon will appear in the header bar when the system is running on battery power and the screen brightness will automatically be reduced. The monitoring system will automatically disable some features to extend battery life.

Check the Battery.

1. Ensure battery switch or key switch is switched ON.
2. Switch AC power switch OFF.
3. The screen should continue to display information with reduced brightness and the battery icon will appear on the screen. If the display is blank, replace the battery.
4. When completed, switch AC power switch ON.

Note

Use only a battery which meets manufacturer's specifications.

Access Control Backup Battery (Optional)

During an AC power failure, the Access Control backup battery provides backup power to operate the magnetic Access Control lock.

Test Access Control Backup Battery.

1. Ensure monitoring system/Access Control battery key switch is switched ON.
2. Switch AC power switch OFF.
3. Attempt to open cabinet door.
4. If door remains locked, battery is functional.
5. If door does not remain locked, replace battery.
6. Switch AC power switch ON.

Remove and Replace Battery

NOTICE

Take care not to short battery terminals to bracket or to each other when removing or attaching terminal connectors, bracket or bracket screws.

1. Switch battery backup key switch OFF; switch AC power switch OFF; disconnect AC power cord from power receptacle.
2. Using a #2 Phillips screwdriver, remove screws securing top cover (*if installed*). Remove cover and set cover and screws aside.
3. Locate 12V Battery, and disconnect wires from terminals on battery.
4. Using a #2 Phillips screwdriver remove two (2) screws from the battery mounting bracket, and remove old battery.
5. Place new battery in same location as one removed.
6. Install bracket over battery and secure with two (2) screws.
7. Reconnect wires to correct terminals.
8. Reinstall top cover (*if removed*) and secure with screws using a #2 Phillips screwdriver.
9. Reconnect AC power cord; switch AC power switch ON; switch battery backup switch ON.



Chart Recorder Backup Battery (if included)

Refer to Temperature Chart Recorder Operation and Service Manual.

4.3 Check Probe Bottle (if installed)

Remove the probe bottle from the bracket and inspect for cracks. Replace the bottle if necessary.

Ensure the probe bottle has approximately 4 oz. (120 mL) of product simulation solution (10:1 ratio of water to glycerin). The glycerin is used to create a solution which simulates the product stored in the refrigerator. The product simulation solution temperature reflects the product's temperature during normal operation. Failure to fill the bottle may prevent the chamber temperature from stabilizing at the temperature setpoint. The probe should be immersed at least 2" (50 mm).

4.4 Display Board Battery

NOTICE

The display board is sensitive to static electricity and can be damaged by electrostatic discharge. Use proper ESD precautions when handling the display board.

Replace Display Board Battery

1. Switch main power switch to OFF, switch battery backup and Access Control key switches to OFF; disconnect AC power cord from power receptacle.
2. Use #2 Phillips screwdriver to remove two (2) screws from the bottom of i.C³ bezel.
3. Gently lift bezel to disconnect it from mounting bracket on front of unit.
4. Locate CR2032 battery and use a small flat head screwdriver to push old battery out of slot.
5. Install new CR2032 battery into slot.
6. Mount bezel to cabinet using (2) screws.
7. Reconnect AC power cord; switch main power switch ON; switch battery backup switch ON.
8. Allow temperature to stabilize at setpoint before moving inventory back into unit.

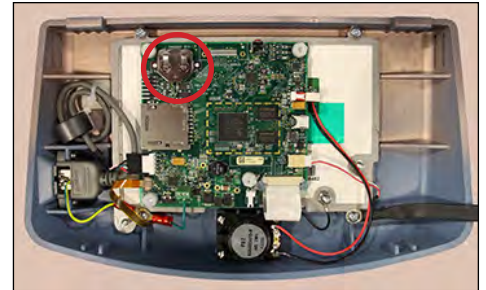

4.5 Upgrade System Firmware

Helmer may occasionally issue updates for the i.C³ firmware. Follow the upgrade instructions included with the firmware update.

4.6 Re-apply Silver Conductive Grease to Upper Door Hinge

NOTICE

Use only conductive grease on upper hinge.

1. Switch main power switch OFF, switch battery backup and maglock key switches OFF; disconnect AC power cord from power receptacle.
2. Using a #2 Phillips screwdriver, remove eight (8) screws securing top cover on refrigerator (*if installed*) and remove cover.
3. Using a #2 screwdriver, remove four (4) screws securing bezel and remove bezel.
4. Use a 5/32 Allen tool to remove two (2) bolts securing upper hinge of door.
5. Slightly tilt door away from refrigerator and lift on upper hinge. Apply small amount of conductive grease to bottom of upper hinge.
6. Insert top hinge back into door and use 5/32 Allen tool to install and secure two (2) bolts into upper hinge.

Note

Verify door is level once upper hinge is secured. If door is not level, loosen upper hinge screws and adjust accordingly.

7. Install bezel and attach with four (4) screws using a #2 Phillips screwdriver.
8. Reinstall top panel and secure with eight (8) screws.
9. Reconnect AC power cord; switch main power switch ON; switch battery backup and maglock key switches ON.
10. Allow temperature to stabilize at setpoint before moving inventory back into unit.

4.7 Clean the Refrigerator

Cabinet Exterior

Clean glass surfaces with soft cotton cloth and glass cleaner. Clean exterior surfaces with soft cotton cloth and non-abrasive liquid cleaner.

Cabinet Interior

Clean painted surfaces with mild detergent. Clean stainless steel surfaces with general-purpose laboratory cleaner suitable for stainless steel.

Condenser Grill

NOTICE

Disconnect refrigerator from AC power when cleaning.

If the refrigerator is located in an environment where it is exposed to excessive lint or dust, the condenser grill may require cleaning more frequently than stated in preventive maintenance schedule.

Clean condenser grill using soft brush and vacuum cleaner.

Door Gasket

Clean with soft cloth and mild soap and water solution.

Probe Bottles (if installed)

Clean and Refill Probe Bottles

1. Remove all probes from bottle.
2. Remove bottle from bracket and empty any remaining solution
3. Clean bottle with a 1:9 ratio of bleach to water solution or a company approved cleaner/disinfectant.
4. Refill bottle with 4 oz. (120 mL) of product simulation solution (10:1 ratio of water to glycerin).
5. Cap bottle tightly to minimize evaporation.
6. Place bottle in bracket.
7. Replace probes, immersing at least 2" (50 mm).

i.C³® Touchscreen

Clean touchscreen with soft, dry cotton cloth.

5 Service

5.1 Refrigerant



Risk of fire or explosion. Flammable refrigerant used. To be repaired only by trained service personnel. DO NOT puncture refrigerant tubing.

NOTICE

- Review all safety instructions prior to recharging refrigerant.
- Maintenance should only be performed by trained refrigeration technicians familiar with hydrocarbon refrigerants.

Table 8. Refrigerant Charge

Model	Refrigerant	Power Requirements	Initial Charge
113	R600a	115V, 60Hz 220-240V, 50/60Hz	3.53 oz. (98g +/- 1g)
120/125	R600a	115V, 60Hz 220-240V, 50/60Hz	3.35 oz. (95g +/- 1g)
245/256	R600a	115V, 60Hz 220-240V, 50/60Hz	3.88 oz. (110g +/- 1g)

5.2 Remove / Replace Unit Cooler Cover

The unit cooler cover must be removed when servicing the control probe, fan motor(s) or coil.

NOTICE

If unit cooler cover is not removed as detailed in this procedure the drain port may be damaged. Improper drainage may result in excessive icing and refrigerator's inability to maintain temperature.



Label	Description
A	Unit cooler cover
B	Drain port

Drain line and hose.

Remove Unit Cooler Cover

1. Switch AC power switch **OFF**. Switch backup battery key switch **OFF**.
2. Using wire cutters, cut wire tie securing drain hose to evaporator drain port.
3. Pull drain hose downward while gently twisting to remove from unit cooler drain port.
4. Hold unit cooler cover in place to prevent dropping. Using an 8mm socket driver, remove four (4) screws securing unit cooler cover.
5. Carefully lower unit cooler cover to avoid damage to fan wiring.

 **Install Unit Cooler Cover**

1. Verify unit cooler wiring is connected and routed correctly.
2. Lift unit cooler cover into place. Front edge of cover should be behind unit cooler case.
3. Secure unit cooler cover with four (4) screws using an 8mm socket driver.
4. In chamber, attach drain hose to unit cooler drain port and secure with wire tie.
5. Switch AC power switch **ON**. Switch backup battery key switch **ON**.
6. Touch **Mute** to disable high temperature alarm while refrigerator reaches operating temperature.

6 Troubleshooting

NOTICE

Review all safety instructions prior to troubleshooting. Refer to Section 1.

6.1 Access System Problems

Problem	Possible Cause	Action
Door does not lock	Lock mechanism is damaged.	Inspect lock/latch, Replace if necessary.
Door does not lock (Magnetic Access Control Option)	Magnetic door lock is not aligned with the strike plate.	Align lock/door to the match strike plate.
	Magnetic lock is not receiving power.	Trace voltage to the lock using the schematic, replace lock if needed.

6.2 Chamber Temperature Problems

Problem	Possible Cause	Action
Display temperature does not match actual chamber temperature	Display temperature needs to be calibrated.	Follow temperature calibration procedure.
	Probe bottle is empty, or probe is out of bottle or ballast.	Check the level of product simulation solution in the bottle. Verify probe is fully inserted in bottle or ballast.
Displayed temperature is too warm or too cold.	Probe bottle is empty, or probe is out of bottle or ballast.	Check the level of product simulation solution in the bottle. Verify probe is fully inserted in bottle or ballast.
	Primary Monitor probe needs to be calibrated.	Calibrate Primary Monitor probe.
	Door was recently opened or opened for an extended time.	Close door and allow temperature to stabilize.
	Condenser coil is dirty	Clean the condenser coil.
	Lack of air flow around unit/ high ambient condition.	Check for proper spacing around unit, any foreign objects blocking air flow, and ambient temperature is within location specifications.
	Lack of air flow inside of chamber.	Check product placement and move products that block air flow around evaporator fan or products which hang over shelves against the back wall.
	Temperature setpoint was adjusted.	Check temperature setpoint and temperature settings. Change to default settings or desired setpoint if necessary.
	Control probe is reading too high/low.	Check control offset setting. Adjust if necessary.
	Unit cooler fan motor (inside chamber) is not running.	Check voltage to the fan motor using schematic. Replace fan motor if necessary.
	Condenser fan motor (exterior) is not running.	Check voltage to the fan motor using schematic. Replace fan motor if necessary.
Compressor is not running.	Check voltage to the compressor using schematic. Replace compressor start components if necessary.	

6.3 Alarm Activation Problems

Problem	Possible Cause	Action
A Battery alarm is active. <i>(Monitoring system/optional Access Control battery backup)</i>	The battery switch is in the off "o" position.	Turn the switch to on "-" position.
	Battery is low due to a power failure.	Allow the battery to recharge.
	Faulty battery or wiring connection.	Check wiring and replace battery.
A Probe Failure alarm is active.	Faulty probe or wiring connection.	Check corresponding probe connection. Test resistance of probe (86Ω to 110Ω). Replace probe if necessary.
The Power Failure alarm is active.	Power was interrupted to refrigerator.	Restore facility power.
	Power switch is in the off "o" position.	Turn power switch to the on "-" position.
	Power cord is loose.	Check both ends of the power cord at the wall outlet and the refrigerator.
	GFI/GFCI outlet has tripped.	Move to standard outlet. Helmer does not recommend operating this unit on a GFI outlet.
The Door Open alarm is activating sporadically.	Door is not closed completely.	Close door.
	Door Alarm delay is set to 0 min.	Check door alarm delay (Default setting - 3 min)
	Faulty door switch or wiring connection.	Check wiring and continuity of switch contacts. Replace switch if necessary.
The Compressor Probe High Temperature alarm is active	Condenser fins are dirty.	Clean condenser coil.
	Condenser probe is out of calibration.	Calibrate condenser probe.
	Condenser probe is faulty.	Check condenser probe connection. Test resistance of probe (86Ω to 110Ω). Replace the probe if needed.
	Ambient conditions are outside of specifications.	Ensure ambient conditions are within location specifications.
A Communication alarm is active.	Communication is lost between i.C3 display board and control board.	Reboot/power cycle the refrigerator. Turn off both main power and battery power, then turn power back on.
	Configuration file is corrupt.	
	i.C ³ is unable to access the configuration file.	
	Corrupt database.	
The Drive Space Low/Drive Space Full alarm is active	SD card is approaching capacity or is full	Replace SD card.

6.4 Condensation Problems

Problem	Possible Cause	Action
Excess condensation/ moisture inside chamber.	Stored liquid spilled within the chamber.	Verify stored liquid products are properly sealed. Clean chamber.
	Unit cooler condensation pan is not draining.	Ensure refrigerator and unit cooler pan are level. Level if necessary for proper gravity fed drainage.
		Check drain line for debris. Flush drain line if necessary.
	Door was open for an extended time.	Close door and allow chamber to stabilize
	Door seal is deficient.	Inspect door seal for damage. Replace seal if necessary.
		Check for wires routed through the door seal. Reroute wires through available access port if necessary.
Check through holes and ensure they are sealed. Reseal if necessary.		

7 i.Series Parts

i Notes

- Before replacing parts, protect items in refrigerator from extended exposure to adverse temperature.
- Allow refrigerator temperature to stabilize at setpoint after replacing parts or after extended door opening.
- Circuit boards are sensitive to static electricity and can be damaged by electrostatic discharge. Use proper ESD precautions when handling the display assembly.

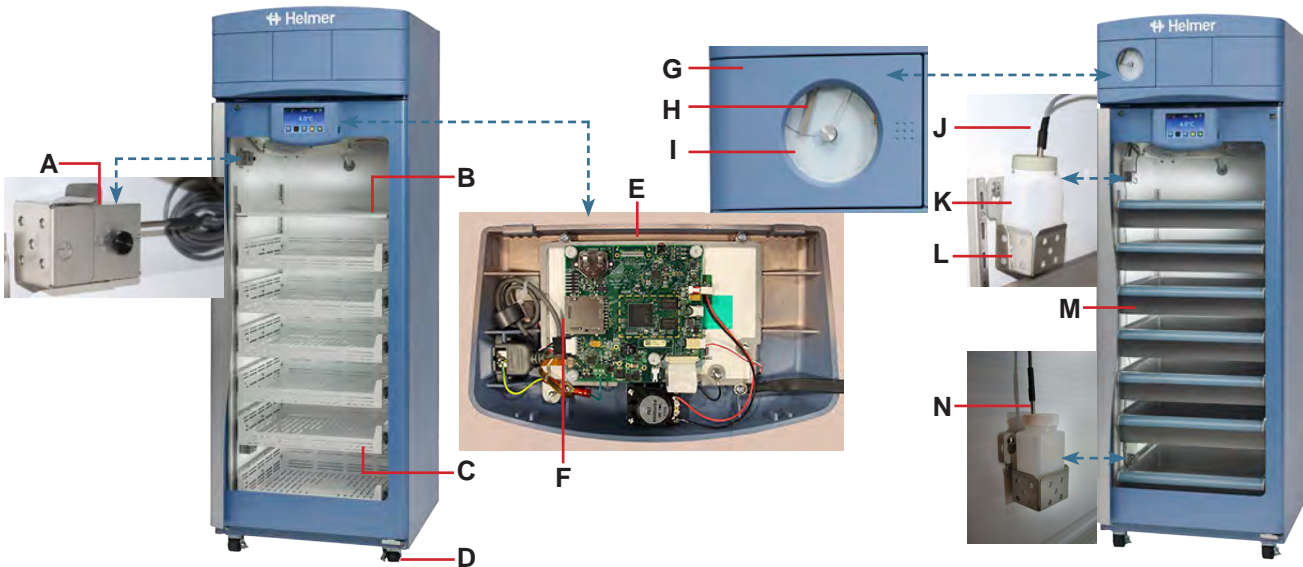

Letter	Description	Part Number	Model	Volt	Letter	Description	Part Number	Model
A	Solid Ballast	402062-1	-	-	I	Chart Paper	220366	-
B	Ventilated Shelf	401956-1-069	113	-	Not shown	Chart Recorder Backup Battery (9V)	120218	-
		402052-1-069	120/245	-	Not shown	Chart Recorder Probe	800024-1	-
		402053-1-069	125/256	-	J	Primary Monitor Probe	800038-1	-
C	Ventilated Drawer (includes slides)	401963-1-069	113	-	K	Probe Bottle (with Glycerin)	400922-1	-
		402042-1-069	120/245	-	L	Probe Bottle/Ballast Holder	320756-4	113/120 125
		402043-1-069	125/256	-			320756-2	245/256
D	Locking Caster	220467	-	-	M	Solid Drawer (includes slides)	401966-2-000	113
E	i.Center Display Assembly	800041-1	-	-	400370-1		120/245	
F	SD Card	800917-1	-	-	400370-2		125/256	
G	Temperature Chart Recorder (TCR)	800025-1	-	115V	N	Secondary Monitor Probe	800037-1	120/245 125/256
		800025-2	-	230V				
H	TCR Stylus Arm (with pen)	400505-1	-	-				

i.Series

NOTICE

Disconnect unit from AC power when replacing LED lamps.

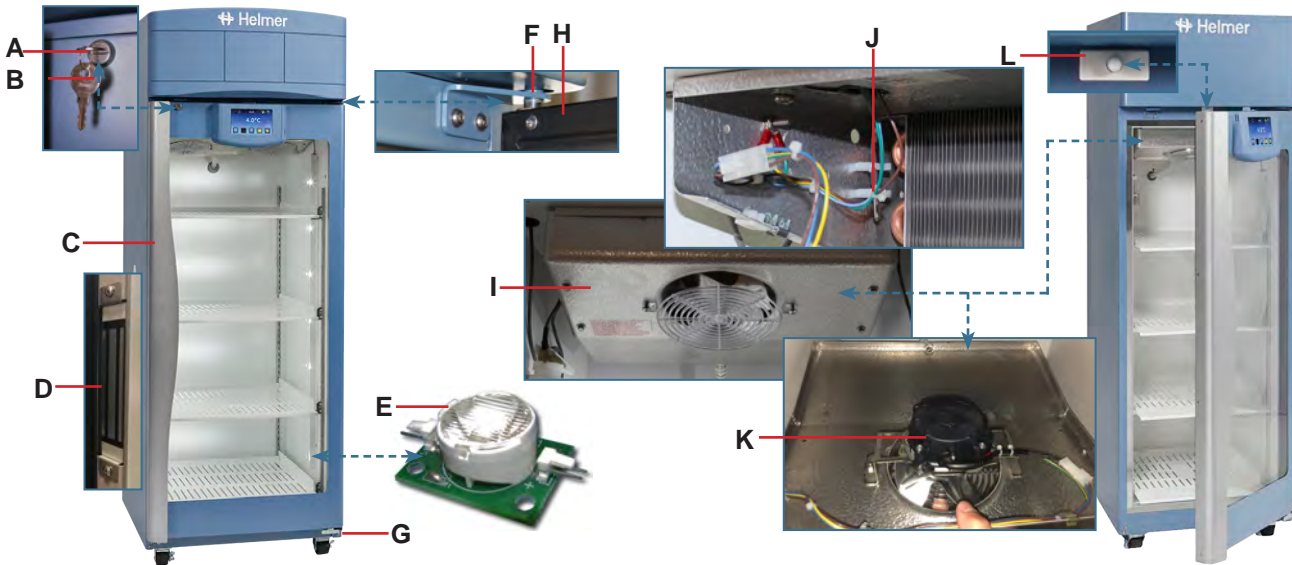

Letter	Description	Model	Part Number	Letter	Description	Model	Part Number
A	Door Lock	-	220540	G	Lower Hinge Assembly (Left)	-	401825-2-067
B	Door Lock Key	-	220630		Lower Hinge Assembly (Right)	-	401825-1-067
C	Door Handle	113	321096-1	H	Door Gasket	113	321082-1
		120/125/245/256	320683-1			120/125/245/256	321271-1
D	Magnetic Lock (solid door)	-	801000-1	I	Unit Cooler Assembly	113	800980-1
	Magnetic Lock (glass door)	-	801000-2			120/125	801051-1
						245/256	801054-1
E	LED Lamp (5 lights; powder coat)	113	800914-1	J	Control Probe	-	800048-1
	LED Lamp (5 lights; powder coat)	120/125	401005-1	K	Unit Cooler Fan Motor	113/120/125	800995-1
	LED Lamp (7 lights; powder coat)	120/125	401002-1			245/256	800995-1
	LED Lamp (10 lights; powder coat)	245/256	401003-1				
	LED Lamp (14 lights; powder coat)	245/256	401004-1	L	Door switch	-	120380
F	Upper Hinge Assembly (Left)	-	400960-2-067				
	Upper Hinge Assembly (Right)	-	400960-1-067				



Risk of fire or explosion. Flammable refrigerant used. To be repaired only by trained service personnel. DO NOT puncture refrigerant tubing.

NOTICE

Disconnect unit from AC power before accessing the electrical panel.

Note

Circuit boards are sensitive to static electricity and can be damaged by electrostatic discharge. User proper ESD precautions when handling board.

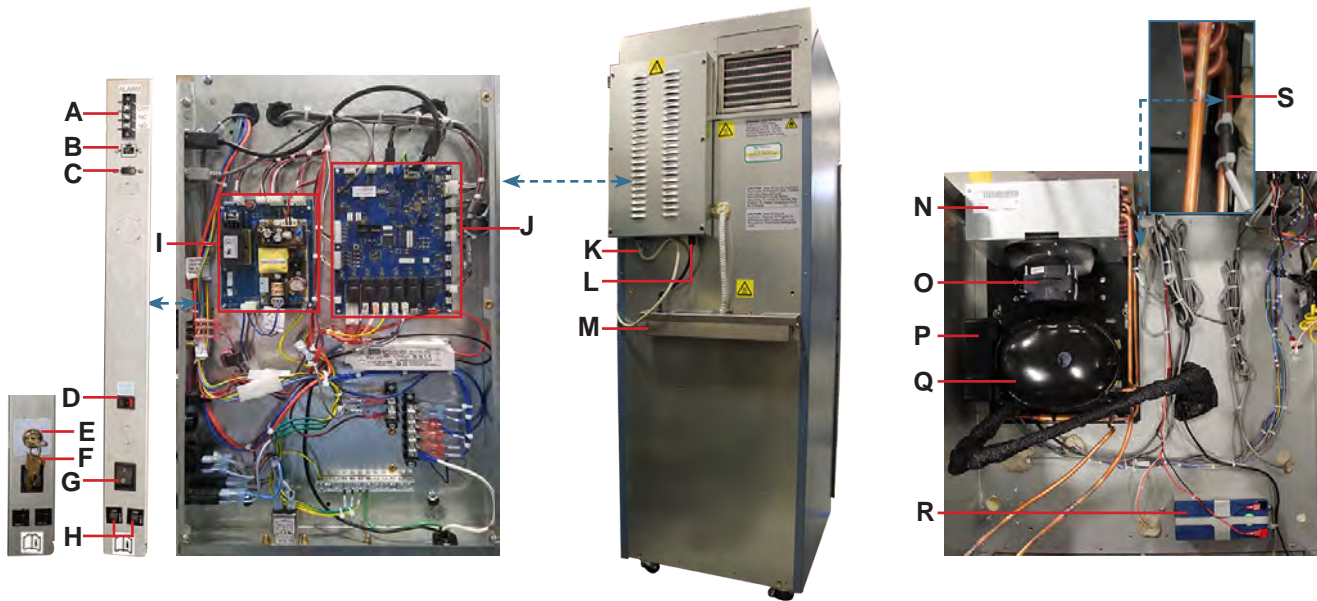

Letter	Description	Part Number	Volts	Letter	Description	Model	Part Number	Volts
A	Remote Alarm Contacts	120404	-	N	Condensing Unit	113	800992-1	115
B	RJ45 Ethernet port	-	-			113	801014-1	230
C	USB port	120633	-			120/125	801052-1	115
D	Backup Battery Switch (no Access Control)	120202	-			120/125	801053-1	230
E	Backup Battery Key Switch (with Access Control)	120754	-			245/256	801055-1	115
F	Backup Battery Key	120895	-			245/256	801056-1	230
G	Main Power Switch	120478	-	O	Condenser Fan Motor	113	800996-1	-
H	Circuit Breaker	120272	-			120/125 245/256	801058-1	-
I	i.C ³ Power Supply Board	800916-1	-	P	Compressor inverter		800997-1	115
J	i.C ³ Control Board	800034-4	-				800998-1	230
K	Power Cord	120630	-	Q	Compressor		-	-
L	Condensate Heater Assembly	401901-1	115	R	i.C ³ Monitoring System Backup Battery		121018	-
		401901-2	230	S	Condenser Temperature Probe		800039-1	-
M	Condensate Evaporator Tray	-	-					

i.Series

8 Schematics

8.1 iBR, iPR and iLR Models

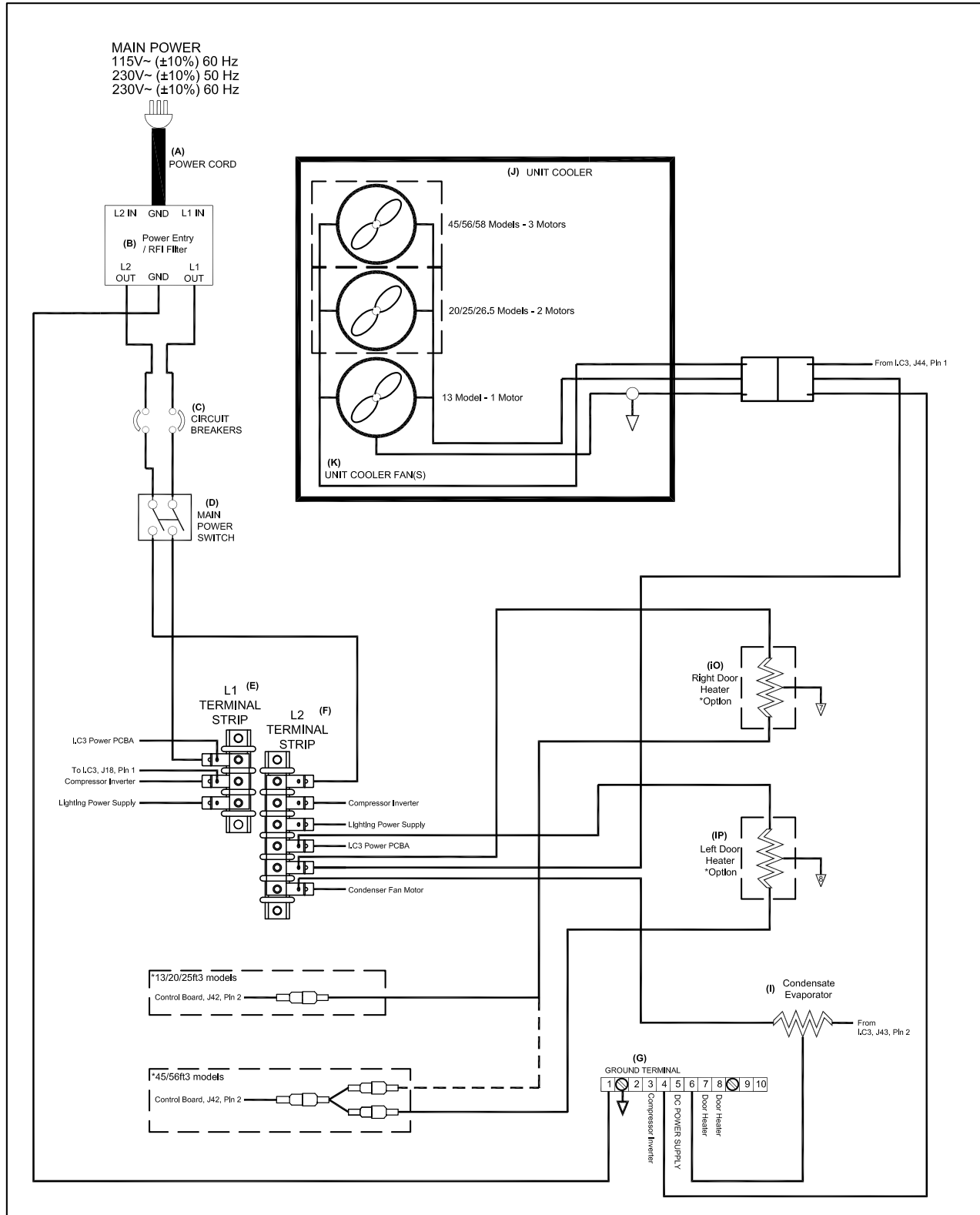

i.Series

THESE DRAWINGS AND SPECIFICATIONS ARE THE SOLE PROPERTY OF HELMER INC. AND SHALL NOT BE REPRODUCED OR USED AS THE BASIS FOR MANUFACTURE OR SALES OF APPARATUS WITHOUT THE APPROVAL OF HELMER INC.

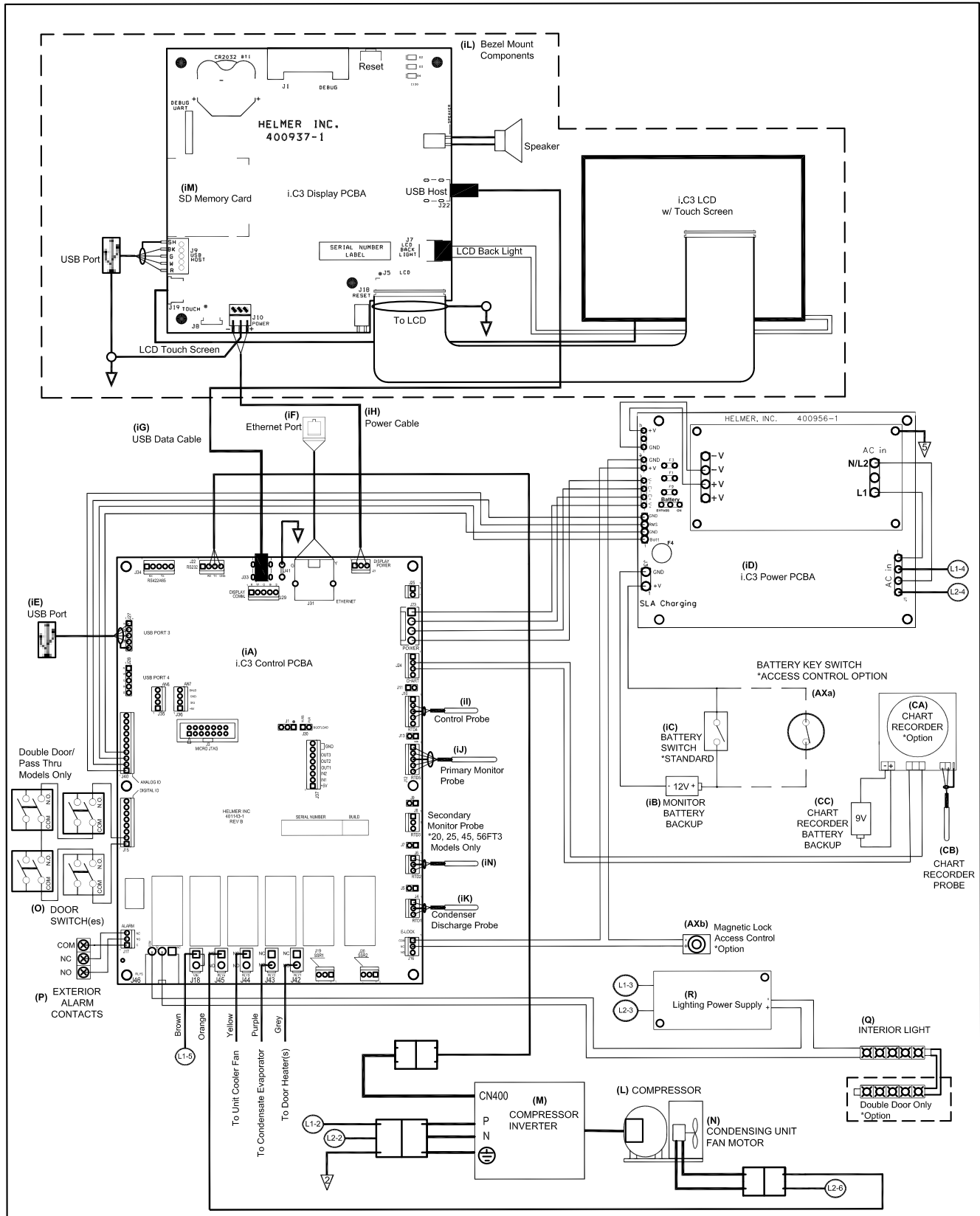

THESE DRAWINGS AND SPECIFICATIONS ARE THE SOLE PROPERTY OF HELMER INC. AND SHALL NOT BE REPRODUCED OR USED AS THE BASIS FOR MANUFACTURE OR SALES OF APPARATUS WITHOUT THE APPROVAL OF HELMER INC.

i.Series

Horizon Series Information

9 Installation and Configuration

9.1 Location Requirements



Keep all ventilation openings in the enclosure or, in the structure for building-in, clear of obstruction.

- ◆ Has a grounded outlet meeting the electrical requirements listed on the product specification label.
- ◆ Is clear of direct sunlight, high temperature sources, and heating and air conditioning vents.
- ◆ Has a minimum 8" (203 mm) above and minimum 3" (76 mm) behind the unit for proper ventilation, clearance and feature access.
- ◆ Meets limits specified for ambient temperature (15°C to 32°C) and relative humidity.

9.2 Placement and Leveling

NOTICE

- Helmer does not recommend operating this unit on a GFI/GFCI outlet.
- The evaporation tray located on the rear of the refrigerator may be hot. Do not use the tray as a handle.
- To prevent tipping, ensure the casters are unlocked, leveling feet (if installed) are lifted, and the doors are closed before moving the refrigerator.
- To avoid damaging refrigerant tubing or risking refrigerant leak, use caution when moving or operating the unit.

1. Ensure door is secured and casters (if installed) are unlocked.
2. Roll refrigerator into place and lock casters.
3. Ensure refrigerator is level.

9.3 Connect Backup Power

The monitoring system, optional Access Control, and chart recorder each have a backup battery system enabling a period of continuous operation if power is lost.

Battery life varies by manufacturer as well as voltage level remaining. Providing full battery power is available, backup power for the monitoring system is available for up to two hours. Providing full power is available, backup power for the optional Access Control system is available for at least 2 hours.

NOTICE

Before installing or replacing batteries, switch main power OFF and disconnect refrigerator from AC power.

Notes

- The optional Access Control system uses an independent battery for backup power.
- If AC power is lost, the monitoring system will automatically disable some features to prolong backup battery power. Data collection will continue until backup battery power is depleted.

The monitoring system and optional Access Control backup batteries are located on top of the refrigerator. A removable panel provides access to the backup battery for 113 models. An optional top panel may be installed on all other models, and must be removed to access the backup battery.

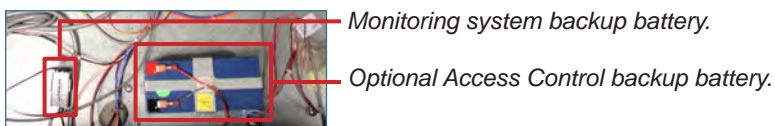

9.4 Prepare for Monitoring

Monitoring system backup battery is included in the accessories box, or installed on the unit but not connected. Install and connect the battery and switch the audible alarm key switch to ON to provide monitoring system with backup power and alarm capability in the event of AC power failure. If included, switch the Access Control backup battery ON to provide the optional Access Control system with backup power in the event of an AC power failure.

Temperature Probes

Notes

- Temperature probes are fragile; handle with care.
- Remote probes may also be introduced through the existing rear port and immersed in existing probe bottle.
- External probes should not be routed into the chamber through the door opening as this can cause issues with the door seal.
- Solid ballast (if installed) should be placed in the bracket in a horizontal position.

A solid ballast or probe bottle and container of glycerin have been provided with this unit. When using the probe bottle, mix the glycerin with water to create a solution which simulates the product stored in the refrigerator. The product simulation solution temperature reflects the product's temperature during normal operation.

The probe bottle should contain 4 oz. (120 mL) of product simulation solution at a 10:1 ratio of water to glycerin.



Probe bottle with probe.



Solid ballast with probe.

Fill Probe Bottle (if included)

1. Remove probe(s) from bottle and remove bottle from bracket.
2. Remove cap and fill with 4 oz. (120 mL) of product simulation solution.
3. Install cap and place bottle in bracket.
4. Replace probe(s), immersing at least 2" (50 mm) in solution.

Install Additional Probe Through Rear Access Port

1. Peel back putty to expose port.
2. Insert probe through port into chamber.
3. Insert probe into bottle or secure in ballast with thumb screw.
4. Replace putty, ensuring a tight seal.

Chart Recorder (if included)

The chart recorder has a backup battery system enabling a period of continuous operation if power is lost. Battery life varies by manufacturer as well as voltage level remaining. Providing full power is available, backup power for the temperature chart recorder is available for up to 14 hours.

Note

- If the chart recorder has been operating on backup battery power, the battery should be replaced to ensure the backup source has proper charge.
- For complete information, refer to the Temperature Chart Recorder Operation and Service Manual.

Set up and Operation

Access chart recorder by pulling the door open.



Install Battery

Connect leads to battery to provide backup power to chart recorder.

Install / Replace Chart Paper

Note

- For accurate temperature reading, ensure the current time is aligned with the time line groove when chart knob is tightened.
- Contact Helmer Technical Service to reorder chart paper.

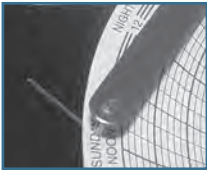

Chart recorder stylus and time line groove

1. Press and hold **C** button. When stylus begins to move left, release button. LED flashes.
2. When stylus stops moving, remove chart knob then move knob up and away.
3. Place chart paper on chart recorder.
4. Gently lift stylus and rotate paper so current time line corresponds to time line groove.
5. Hold chart paper in place while making sure chart knob is fully tightened. *(Failure to fully tighten the knob can result in paper slipping and losing time.)*
6. Press and hold **C** button. When stylus begins to move right, release button.
7. Confirm stylus is marking on paper and stops at correct temperature.
8. Calibrate chart recorder to match primary temperature if needed and close recorder door.

External Monitoring Devices

The remote alarm interface is a relay switch with three terminals:

- ◆ Common (COM)
- ◆ Normally Open (NO)
- ◆ Normally Closed (NC)

Terminals are dry contacts and do not supply voltage. Interface circuit is either normally open or normally closed, depending on terminals used.

Requirements for your alarm system determine which alarm wires must connect to terminals.

NOTICE

- The interface on the remote alarm monitoring system is intended for connection to the end user's central alarm system(s) that uses normally open or normally closed dry contacts.
- If an external power supply exceeding 33 V (AC) RMS or 30 V (DC) is connected to the remote alarm monitoring system's circuit, the remote alarm will not function properly and may cause damage to the control board or result in injury to the user.

The terminals on the remote alarm interface have the following maximum load capacity:

- ◆ 115V or 230V: 1 A at 33 V (AC) RMS or 30 V (DC)

Connect to Remote Alarm Interface

1. On electrical box, locate remote alarm terminals.
2. Connect remote alarm wires to appropriate terminals, according to requirements for your alarm system.
3. Use cable tie to relieve strain on alarm wires (as necessary).

9.5 Configure Storage

NOTICE

- Before moving drawers or shelves, ensure they are completely empty for safe lifting.
- Maximum drawer or shelf load is 100 lbs (46 kg).

Note

Before moving storage components, protect stored items in refrigerator from extended exposure to adverse temperature.

Product Loading Guidelines

When loading your refrigerator, take care to observe the following guidelines:

- ◆ Never load refrigerator beyond capacity.
- ◆ Always store items within shelves or drawers.
- ◆ Temperature uniformity is maintained by air circulation, which could be impeded if unit is overfilled, particularly at the top or back. Ensure a minimum of 2" (50 mm) clearance is provided below the fan.

Note

Products stacked against back wall may obstruct air flow and affect performance of unit.

Drawers

Remove a Drawer

1. Pull drawer out until it stops.
2. Tilt front of the drawer upward.
3. Pull drawer free of the slides.

Install a Drawer

1. Align end guides on drawer with slides.
2. Gently push drawer into chamber until it stops.
3. Pull drawer out until it stops; check for smooth operation.

Move Drawer Slides

1. Using a screwdriver, remove bracket retainers.
2. Tap brackets upward to disengage standards.
3. Remove slides from standards
4. Insert slides into standard at appropriate height.
5. Tap brackets downward to engage standards.
6. Using a screwdriver, install bracket retainers.

Shelves

Remove a Shelf

1. With one hand, lift front edge of shelf from front brackets.
2. With other hand, reach under shelf and bump rear edge of shelf upward to disengage rear brackets.

Install a Shelf

1. Insert shelf into chamber, placing it on the rear brackets and with the front edge of the shelf angled upward approximately 8 inches.
2. Lower the front edge and gently bump rear edge of shelf downward to engage with brackets.
3. Pulling shelf forward gently, shelf should not disengage from rear brackets.

Move Shelf Brackets

1. Using a screwdriver, remove bracket retainers.
2. Tap brackets upward to disengage standards.
3. Remove brackets from standards.
4. Insert front brackets into standard at appropriate height.
5. Tap brackets downward to engage standards.
6. Using a screwdriver, install bracket retainers.

9.6 Optional Adapter Kits for Medication Dispensing Locks

Contact Helmer Technical Service or your distributor for service documentation pertaining to medication dispensing lock adapter kits.

10 Controls

Horizon Series models are equipped with a monitor and optional control system which allows users to view and change current settings.

10.1 Monitor and Control Interface

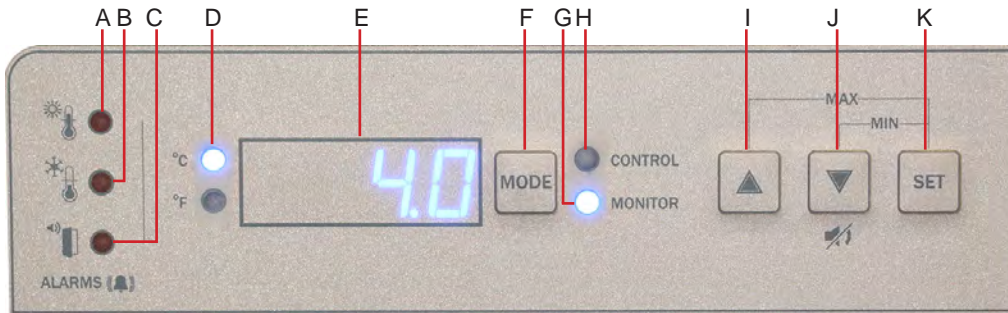

Table 9. Monitor and Control Indications

Label	Description	Function
A	HIGH TEMP lamp	Indicates when the refrigerator is in a high temperature alarm condition. Also indicates the high alarm temperature setpoint is being changed.
B	LOW TEMP lamp	Indicates when the refrigerator is in a low temperature alarm condition. Also indicates the low alarm temperature setpoint is being changed.
C	DOOR OPEN lamp	Indicates when refrigerator door is open.
D	Temperature Unit Indicator	Indicates temperature reading is in °C or °F.
E	Display	Displays real-time temperature information, setpoints, and alarms.
F	MODE button	Allows selection of CONTROL or MONITOR mode.
G	MONITOR lamp	Indicates when the display is showing temperature readings from the monitor probe. Also indicates when alarm setpoints are being changed.
H	CONTROL lamp	Indicates when the reading from the control probe is displayed.
I	UP ARROW button	Increases a temperature setting.
J	DOWN ARROW / MUTE ALARM button	Decreases a temperature setting. Also mutes the audible alarm for 5 minutes.
K	SET button	Allows settings to be selected, prior to changing settings.

Note

The Alarm Disable key switch disables all audible alarms. This switch does not affect alarm lamps or signals sent through the remote alarm interface.

Display Minimum and Maximum Monitor Temperature Recordings

The minimum and maximum recording feature allows the user to view a minimum temperature occurrence and a maximum temperature occurrence within a given period of time. The timer provides a time reference in which those temperatures occurred.

View *Minimum* Temperature Recording

- ◆ Press and hold **Down Arrow** button for 1 second and listen for a single beep. 
- ◆ Display will alternate between **LO** and valid temperature value five (5) times followed by single beep to indicate exit back to temperature display.



View *Maximum* Temperature Recording

- ◆ Press and hold **Up Arrow** button for 1 second and listen for a single beep. 
- ◆ Display will alternate between **HI** and a valid temperature value five (5) times followed by a single beep to indicate exit back to temperature display.



View Recorded Temperature Timer

Notes

- The timer denotes the period of time that has elapsed. It does not display the time at which a minimum or maximum temperature occurred.
- The maximum period of time the timer can record is 99:59 (99 hours and 59 minutes).

- ◆ Press and hold either **Up** or **Down Arrow** button for 1 second.  or 
- ◆ While display is flashing **HI** or **LO** value, press and hold **SET** button for 1 second.
- ◆ Display will alternate five (5) times between **CLr** and a value representing number of hours and minutes that have elapsed since last recording (example: 12:47 would represent 12 hours and 47 minutes). A single beep will follow to indicate exit back to temperature display.

Clear Minimum and Maximum Temperature Recordings

- ◆ Press and hold either **Up** or **Down Arrow** button for 1 second.  or 
- ◆ While display is flashing **HI** or **LO** value, press and hold **SET** button for 1 second and listen for a single beep.
- ◆ While display is flashing elapsed time since last reset, press and hold **SET** button for 2 seconds. **CLr** will be displayed followed by a series of 3 beeps to indicate exit back to temperature display.

Notes

The minimum and maximum temperature and timer will reset when:

- the unit is powered off and battery backup is not engaged, or
- after 99 hours and 59 minutes have elapsed.

10.2 Alarm Reference

If an alarm condition is met, an alarm activates. Some alarms are visual only; others are visual and audible. Some alarms are sent through the remote alarm interface.

The table indicates if an alarm is audible (A), visual (V), or sent through the remote alarm interface (R).

Note

If the system is in Power Failure (PoFF) alarm, an Er05 error can be expected as a result of the absence of power to the compressor inverter.

Table 10. Alarm Indications

Alarm	Alarm Type	Visual Indicator
High Temperature (Primary Monitor Probe)	A, V, R	HIGH TEMP Lamp
Low Temperature (Primary Monitor Probe)	A, V, R	LOW TEMP Lamp
Display/Control Board Communication Error	A, V, R	Er04
Control Board to Compressor Inverter Error	A, V, R	Er05
Door Open (Time)	A, V, R	DOOR OPEN Lamp (<i>flashes after 3 minutes</i>)
Power Failure	A, V, R	PoFF
Probe Failure	Control (RTD1)	Er01
	Primary Monitor (RTD2)	Er02
No Battery	V	Er06
Configuration Error	A, V, R	Er07

10.3 Settings

Temperature Setpoint

The default setpoint for the refrigerator is 4.0 °C for HBR and HLR models, and 5.0 °C for HPR models. This can be changed if your organization requires a chamber temperature other than the default setting.

Change Setpoint:

Note

The current temperature setpoint is typically higher than the chamber temperature.

1. Press and release **MODE** to change to Control mode. CONTROL lamp will illuminate.
2. Press and hold **SET** to display current temperature setpoint.
3. Hold **SET** and press **Up** or **Down Arrow** as necessary to set desired setpoint value.
4. Release **SET** button. Setpoint is changed.
5. Press and release **MODE** to return to Monitor mode. MONITOR lamp will illuminate.

Temperature Settings

Temperature settings are factory pre-set. Settings can be viewed and changed through the Monitor and Control interface.

Table 11. Parameters, Indicators and Settings

Parameter	Visual Indicator	Range	Default
Celsius or Fahrenheit	°C Lamp or °F Lamp	.C, .F	.C
High Temperature	MONITOR Lamp & HIGH Lamp	-40.0 to 25.0 (°C); -40 to 77 (°F)	5.5 °C (HBR and HLR models) 6.5 °C (HPR models)
Low Temperature	MONITOR Lamp & LOW Lamp	-40.0 to 25.0 (°C); -40 to 77 (°F)	1.5 °C (HBR models) 2.0 °C (HLR and HPR models)
Monitor Offset	MONITOR Lamp only	-10.0 to 10.0 (°C); -18 to 18 (°F)	Varies
Control Offset	CONTROL Lamp only	-10.0 to 10.0 (°C); -18 to 18 (°F)	Varies
Upper Rail Limit	CONTROL Lamp and HIGH Lamp	0.1 to 10.0 (°C); 1 to 18 (°F)	0.7 °C
Lower Rail Limit	CONTROL Lamp and LOW Lamp	0.1 to 10.0 (°C); 1 to 18 (°F)	-0.7 °C

View Settings and Offset Values

1. Press and hold **Up** and **Down Arrows** simultaneously for 3 seconds to enter program mode.
2. LED Display will show .C or .F to indicate Celsius or Fahrenheit.
3. Press and release **MODE** to scroll through parameters and view settings.
4. Hold **Up** and **Down Arrows** simultaneously for 3 seconds to exit program mode.
5. LED Display will show current monitor temperature.

Temperature Units

Note

If temperature units are changed, the temperature setpoints, offsets and alarm settings must be recalibrated.

Select Temperature Units

1. Press and hold **Up** and **Down Arrows** simultaneously for 3 seconds to enter program mode.
2. LED Display will show .C or .F to indicate Celsius or Fahrenheit.
3. Press and hold **SET** button while pressing **Up** or **Down Arrow** to select desired temperature unit parameter.
4. Release **SET** button. New setting is saved.
5. Press and hold **Up** and **Down Arrows** simultaneously for 3 seconds to exit program mode.

Alarm Settings

The high and low temperature alarm settings may be changed by the operator. Temperature alarm setpoints specify the temperature at which an alarm activates. The setpoint for temperature alarms may be changed.

High Temperature Alarm

Change the Alarm Setpoint

1. Press and hold **Up** and **Down Arrows** simultaneously for 3 seconds to enter program mode.
2. LED Display will show .C or .F to indicate Celsius or Fahrenheit.
3. Press **MODE** until HIGH TEMP and MONITOR lamps flash.
4. Hold **SET**, then press **Up** or **Down Arrow** to change setpoint.
5. Release **SET** button. New setting is saved.
6. Press and hold **Up** and **Down Arrows** simultaneously for 3 seconds to exit program mode.

Low Temperature Alarm

Change the Alarm Setpoint

1. Press and hold **Up** and **Down Arrows** simultaneously for 3 seconds to enter program mode.
2. LED Display will show .C or .F to indicate Celsius or Fahrenheit.
3. Press **MODE** until LOW TEMP and MONITOR lamps flash.
4. Hold **SET**, then press **Up** or **Down Arrow** to change setpoint.
5. Release **SET** button. New setting is saved.
6. Press and hold **Up** and **Down Arrows** simultaneously for 3 seconds to exit program mode.

Primary Monitor Probe

Verify the primary monitor probe is reading chamber temperature correctly by comparing primary monitor probe readings to the temperature measured by a calibrated reference thermometer. If the primary monitor probe is not reading correctly, change the monitor offset value displayed.

Notes

- Ensure product simulation bottle (if installed) is full of solution.
- The probe in the bottle or ballast is connected to the monitoring system and represents product storage temperature. This probe does not affect the temperature control.
- For units with a solid ballast, Helmer recommends using putty to seal the probe hole when using a thermocouple wire to calibrate.

Calibrate Primary Monitor Probe *(probe bottle installed)*

- 1 Remove primary monitor probe from probe bottle.
- 2 Unscrew cap from bottle.
- 3 Attach calibrated independent reference thermometer traceable per national standards to primary monitor probe, and place them in bottle. The probe and thermometer should be immersed at least 2" (50 mm).
- 4 Close door and allow chamber temperature to stabilize.
- 5 Observe and note thermometer temperature. Compare to chamber temperature displayed on monitor. If independent thermometer corresponds to displayed temperature, proceed to **Step 7**.
- 6 Adjust monitor offset value higher or lower to reflect difference between chamber temperature displayed on monitor and temperature reading from calibrated reference thermometer.
- 7 Remove reference thermometer from probe.
- 8 Replace bottle cap, ensuring tight fit.
- 9 Place probe in bottle, immersing at least 2" (50 mm).

Calibrate Primary Monitor Probe *(solid ballast installed)*

- 1 Ensure Primary Monitor Probe is securely installed in ballast.
- 2 Place calibrated independent reference thermometer in one remaining probe hole in ballast and tighten thumb screw to secure. This may involve temporarily removing an additional probe to provide an opening for independent reference thermometer. (Take care not to over-tighten thumb screw,)
- 3 Close door and allow chamber temperature to stabilize.
- 4 Observe and note thermometer temperature. Compare to chamber temperature displayed on monitor. If independent thermometer corresponds to displayed temperature, proceed to **Step 6**.
- 5 Adjust the monitor offset value higher or lower to reflect difference between chamber temperature displayed on monitor and temperature reading from calibrated reference thermometer.
- 6 Loosen thumb screw and remove calibrated independent reference thermometer from ballast.
- 7 Replace any additional probe removed previously, and tighten thumb screw ensuring snug fit.
- 8 Replace any removed putty.

 **Enter the New Offset Value:**

1. Press and hold **Up** and **Down Arrows** simultaneously for 3 seconds to enter program mode.
2. Display will show .C or .F to indicate Celsius or Fahrenheit.
3. Press **MODE** until MONITOR lamp flashes.
4. Hold **SET**, then press **Up** or **Down Arrow** to change monitor offset.
5. Release **SET** button. New setting is saved.
6. Press and hold **Up** and **Down Arrows** simultaneously for 3 seconds to exit program mode.

Control Sensor

The temperature controller senses unit cooler temperature through the control probe in the unit cooler. The unit cooler temperature typically varies from the chamber temperature, so an offset value is used by the control system to compensate for the difference.

The temperature controller adjusts chamber temperature around the refrigerator setpoint.

 **Determine Control Sensor Offset:**

 **Notes**

Control Sensor Offset is factory-preset and changing this value is not recommended. Contact Helmer Technical Service for questions regarding the Control Sensor Offset.

1. View and record Refrigerator Setpoint. (Reference Section 10.3)
2. Allow unit to run with calibrated monitor temperature for several compressor cycles, and record average monitor temperature. *(If monitor temperature remains close to refrigerator setpoint no further action is needed.)*
3. View and record current Control Offset value.
4. Subtract Refrigerator Setpoint from average monitor temperature and record difference.
5. Add current Control Offset value to recorded difference determined in previous step to establish new Control Offset value.

Example 1	Example 2
Refrigerator setpoint is 4.0	Refrigerator setpoint is 4.0
Average monitor temperature is 5.2	Average monitor temperature is 2.8
Current Control Offset is 0.3	Current Control Offset is 0.3
Subtract: $5.2 - 4.0 = 1.2$; difference between average temperature and setpoint.	Subtract: $2.8 - 4.0 = -1.2$; difference between average temperature and setpoint.
Add: $0.3 + 1.2 = 1.5$; new control offset value	Add: $0.3 + (-1.2) = -0.9$; new control offset value

 **Enter the New Offset Value:**

1. Press and hold **Up** and **Down Arrows** simultaneously for 3 seconds to enter program mode.
2. Display will show .C or .F to indicate Celsius or Fahrenheit.
3. Press **MODE** until only CONTROL lamp flashes.
4. Hold **SET**, then press **Up** or **Down Arrow** to change setpoint.
5. Release **SET** button. New setting is saved.
6. Press and hold **Up** and **Down Arrows** simultaneously for 3 seconds to exit program mode.

Horizon Series

Upper Rail

The Upper Rail Limit is the maximum control temperature at which the compressor will turn on.

Lower Rail

The Lower Rail Limit is the minimum control temperature at which the compressor will turn off.

NOTICE

The Upper Rail and Lower Rail values are factory-preset and should not be changed unless directed by Helmer Technical Service.

Non-Configurable Alarms

The Power Failure and Door Open alarms indicate operational conditions which may require the attention of the operator or a qualified service technician. The Power Failure alarm will activate immediately upon loss of power. The Door Open alarm will activate once the door has remained open for approximately three minutes. These settings are factory-preset and may not be changed.

11 Maintenance

Maintenance tasks should be completed according to the schedule below.

NOTICE

- Review all safety instructions prior to recharging refrigerant.
- Maintenance should only be performed by trained refrigeration technicians.

Notes

- The preventive maintenance schedule provides recommended minimum requirements. Regulations or physical conditions at your organization may require maintenance items to be performed more frequently, or only by designated service personnel.
- Before performing maintenance, protect items in refrigerator from extended exposure to adverse temperature.
- Allow refrigerator temperature to stabilize at setpoint after performing service or after extended door opening.

Table 11. Horizon Series Preventive Maintenance Schedule

Task	Frequency		
	1 year	2 years	As Needed
Test the high temperature <i>(over maximum temperature limit)</i> and low temperature <i>(below minimum temperature limit)</i> alarms <i>(as required by your organization's protocols)</i> .			✓
Test the power failure alarm <i>(as required by your organization's protocols)</i> .			✓
Test the door alarm <i>(as required by your organization's protocols)</i> .			✓
Verify the temperature calibration on the monitor and change it if necessary.	✓		
Replace monitoring system backup battery.	✓		
Examine probe bottle <i>(if installed)</i> and clean or replace if necessary.	✓		
Check the solution level in the probe bottle <i>(if installed)</i> . Refill or replace if necessary.			✓
Check the chamber lights and replace if necessary.			✓
Clean the door gaskets, interior, and exterior of the refrigerator.			✓
Clean the condenser grill.			✓
Replace optional Access Control backup battery.		✓	
Models with chart recorders			✓
Check the backup battery for the chart recorder after an extended power failure and change it if necessary, or change the battery if it has been in service for one year. Refer to the Temperature Chart Recorder Operation and Service Manual.			✓

NOTICE

Clean the condenser grill regularly. Dust accumulation on the condenser coil will vary based on the environment. Some environments require quarterly cleaning.

Note

During a power failure the monitoring system backup battery provides power to the monitoring system and power failure alarm. If the backup battery is not functioning, the power failure alarm will not be activated and the battery should be replaced.

11.1 Alarm Tests

Alarms should be tested to ensure they are working correctly. The refrigerator has alarms for chamber temperature, power failure, and door open (time).

Chamber Temperature Alarm Test

NOTICE

- Perform the low alarm test before the high alarm test to control the temperature more closely and complete the testing more quickly.
- Before testing alarms, protect items stored in the unit from extended exposure to adverse temperature.
- Temperature probes are fragile; handle with care.

Test the Low Alarm:

1. Identify setting for low alarm setpoint.
2. Remove primary monitor probe from bottle or solid ballast.
3. Immerse probe in glass filled with water that is approximately 4 °C.
4. Slowly add crushed ice to lower temperature.
5. When temperature reaches the low alarm setting, an alarm will activate.

Test the High Alarm:

1. Identify setting for high alarm setpoint
2. Immerse probe in glass filled with water that is approximately 4 °C.
3. Slowly add warm water to raise temperature.
4. When temperature reaches the high alarm setting, an alarm will activate.
5. Remove probe from warm water.
6. Place primary monitor probe in probe bottle immersing it at least 2" (50 mm), or place in ballast and secure with thumbscrew taking care not to overtighten.

Power Failure Alarm Test

Note

During a power failure, the backup battery should continue to provide power to the monitoring system.

1. Switch AC power switch OFF. Audible power failure alarm will activate by displaying "PoFF" (power off) and an audible tone can be heard approximately every 30 seconds.
2. Switch AC power switch ON. Audible power failure alarm will cease and "PoFF" will clear from display.

Door Open Alarm Test

Note

Factory-set to three minutes and cannot be changed.

1. Open refrigerator door and note time.
2. After three minutes, audible alarm will activate and DOOR ALARM lamp will flash.
3. Close refrigerator door. Audible door open alarm will cease and DOOR ALARM lamp will stop flashing.

11.2 Test and Replace Backup Batteries

Check Monitoring System Battery

The monitoring system does not indicate the charge level of the battery. Regularly test the battery and replace battery if the test fails or if the battery has been in use for one year.

Note

Use only a battery which meets manufacturer's specifications.

Test the Battery:

1. Switch AC power switch OFF.
2. Display should continue to display information.
3. If display is blank, replace battery.
4. Switch AC power switch ON.

Check Optional Access Control System Battery

During an AC power failure, the Access Control backup battery provides backup power to the magnetic Access Control lock. Test the Access Control backup battery to ensure it is working properly.

Test the Battery:

1. Ensure Access Control backup battery key switch is switched ON.
2. Switch AC power switch OFF.
3. Verify "PoFF" (power failure) message is displayed.
4. Attempt to open cabinet door, if door remains locked, battery is functional. If door does not remain locked, replace battery.
5. Switch AC power switch ON.

Remove and Replace Battery

NOTICE

Take care not to short battery terminals to bracket or to each other when removing or attaching terminal connectors, bracket or bracket screws.

1. Switch battery backup key switch OFF; switch AC power switch OFF; disconnect AC power cord from power receptacle.
2. Using a #2 Phillips screwdriver, remove screws securing top cover (*if installed*). Remove cover and set cover and screws aside.
3. Locate 12V Battery. Remove wires from terminals and using a #2 Phillips screwdriver, remove two (2) screws from battery mounting bracket. Remove old battery.
4. Place new battery in same location as one removed.
5. Install bracket over battery and secure with two (2) screws.
6. Reconnect wires to correct terminals.
7. Reinstall top cover (*if removed*) and secure with screws using a #2 Phillips screwdriver.
8. Reconnect AC power cord; switch AC power switch to ON; switch battery backup key switch to ON.

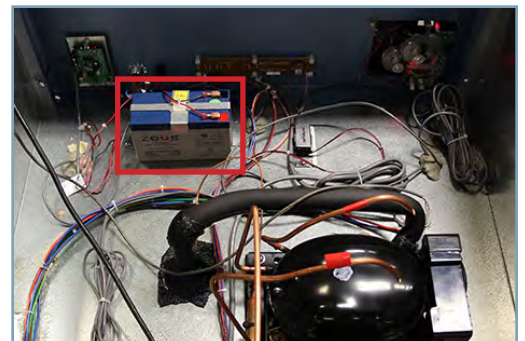

Chart Recorder Backup Battery (if included)

Refer to the Temperature Chart Recorder Operation and Service Manual.

11.3 Check Probe Bottle (if installed)

Remove the probe bottle from the bracket and inspect for cracks. Replace the bottle if necessary.

Ensure the probe bottle has approximately 4 oz. (120 mL) of product simulation solution (10:1 ratio of water to glycerin). The glycerin is mixed with water to create a solution which simulates the product stored in the refrigerator. The product simulation solution temperature reflects the product's temperature during normal operation. Failure to fill the bottle may prevent the chamber temperature from stabilizing at the temperature setpoint. The probe should be immersed at least 2" (50 mm).

11.4 Clean the Refrigerator

Cabinet Exterior

Clean glass surfaces with a soft cotton cloth and glass cleaner. Clean exterior surfaces with a soft cotton cloth and non-abrasive liquid cleaner.

Cabinet Interior

Clean painted surfaces with mild detergent. Clean stainless steel surfaces with a general-purpose laboratory cleaner suitable for stainless steel.

Condenser Grill

NOTICE

Disconnect refrigerator from AC power when cleaning condenser grill.

If the refrigerator is located in an environment where it is exposed to excessive lint or dust, the condenser grill may require cleaning more frequently than stated in preventive maintenance schedule.

Clean the condenser grill using a soft brush and a vacuum cleaner.

Door Gaskets

Clean with a soft cloth and mild soap and water solution.

Probe Bottle (if installed)

Clean and Refill Probe Bottle

1. Remove all probes from bottle.
2. Remove bottle from bracket and empty any remaining solution.
3. Clean bottle with a 1:9 ratio of bleach to water solution or a company approved equivalent oxidizing cleaner/disinfectant.
4. Refill bottle with 4 oz. (120 mL) of product simulation solution (10:1 ratio of water to glycerin).
5. Cap bottle tightly to minimize evaporation.
6. Place bottle in bracket.
7. Replace probes, immersing at least 2" (50 mm).

12 Service

12.1 Refrigerant



Risk of fire or explosion. Flammable refrigerant used. To be repaired only by trained service personnel. DO NOT puncture refrigerant tubing.

NOTICE

- Review all safety instructions prior to recharging refrigerant.
- Maintenance should only be performed by trained refrigeration technicians familiar with hydrocarbon refrigerants.

Table 8. Refrigerant Charge

Model	Refrigerant	Power Requirements	Initial Charge
113	R600a	115V, 60Hz 220-240V, 50/60Hz	3.53 oz. (98g +/- 1g)
120/125	R600a	115V, 60Hz 220-240V, 50/60Hz	3.35 oz. (95g +/- 1g)
245/256	R600a	115V, 60Hz 220-240V, 50/60Hz	3.88 oz. (110g +/- 1g)

12.2 Remove / Replace Unit Cooler Cover

The unit cooler cover must be removed when service to the control probe, fan motor(s) or coil is performed.

NOTICE

If unit cooler cover is not removed as detailed in this procedure the drain port may be damaged. Improper drainage may result in excessive icing and refrigerator's inability to maintain temperature.



Label	Description
A	Unit cooler cover
B	Drain port

Drain line and hose.

Remove the Unit Cooler Cover

1. Switch AC power switch **OFF**. Switch backup battery key switch **OFF**.
2. Using wire cutters, cut wire tie securing drain hose to evaporator drain port.
3. Pull drain hose downward while gently twisting to remove from unit cooler drain port.
4. Hold unit cooler cover in place to prevent dropping. Using an 8mm socket driver, remove four (4) screws securing unit cooler cover.
5. Carefully lower unit cooler cover to avoid damage to fan wiring.

Install the Unit Cooler Cover

1. Verify unit cooler wiring is connected and routed correctly.
2. Lift unit cooler cover into place. Front edge of cover should be behind unit cooler case.
3. Secure unit cooler cover with four (4) screws using an 8mm socket driver.
4. In chamber, attach drain hose to unit cooler drain port and secure with wire tie.
5. Switch AC power switch **ON**. Switch backup battery key switch **ON**.
6. Touch **Mute** to disable high temperature alarm while refrigerator reaches operating temperature.

13 Troubleshooting

NOTICE

Review all safety instructions prior to troubleshooting. Refer to Section 1.

13.1 Access System Problems

Problem	Possible Cause	Action
Door does not lock	Lock mechanism is damaged.	Inspect lock/latch, Replace if necessary.
Door does not lock (Magnetic Access Control Option)	Magnetic door lock is not aligned with the strike plate.	Align lock/door to the match strike plate.
	Magnetic lock is not receiving power.	Trace voltage to the lock using the schematic, replace lock if needed.

13.2 Chamber Temperature Problems

Problem	Possible Cause	Action
Display temperature does not match actual chamber temperature	Display temperature needs to be calibrated.	Follow temperature calibration procedure.
	Probe bottle is empty, or probe is out of bottle or ballast.	Check the level of product simulation solution in the bottle. Verify probe is fully inserted in bottle or ballast.
Displayed temperature is too warm or too cold.	Probe bottle is empty, or probe is out of bottle or ballast.	Check the level of product simulation solution in the bottle. Verify probe is fully inserted in bottle or ballast.
	Primary Monitor probe needs to be calibrated.	Calibrate Primary Monitor probe.
	Door was recently opened or opened for an extended time.	Close door and allow temperature to stabilize.
	Condenser coil is dirty	Clean the condenser coil.
	Lack of air flow around unit/ high ambient condition.	Check for proper spacing around unit, any foreign objects blocking air flow, and ambient temperature is within location specifications.
	Lack of air flow inside of chamber.	Check product placement and move products that block air flow around evaporator fan or products which hang over shelves against the back wall.
	Temperature setpoint was adjusted.	Check temperature setpoint and temperature settings. Change to default settings or desired setpoint if necessary.
	Control probe is reading too high/low.	Check control offset setting. Adjust if necessary.
	Unit cooler fan motor (inside chamber) is not running.	Check voltage to the fan motor using schematic. Replace fan motor if necessary.
	Condenser fan motor (exterior) is not running.	Check voltage to the fan motor using schematic. Replace fan motor if necessary.
	Compressor is not running.	Check voltage to the compressor using schematic. Replace compressor start components if necessary.

13.3 Alarm Activation Problems

Problem	Possible Cause	Action
Probe failure alarm is active (ER01 monitor or ER02 control)	Faulty probe or wiring connection.	Check corresponding probe connection.
		Test resistance of probe (86Ω to 110Ω). Replace probe if necessary.
Power failure alarm is active. (POFF)	Power was interrupted to refrigerator.	Restore facility power.
	Power switch is in the off "o" position.	Turn power switch to the on "-" position.
	Power cord is loose.	Check the power cord at the power receptacle on the wall and on the refrigerator.
	GFI/GFCI outlet has tripped.	Move to standard outlet. Helmer does not recommend operating this unit on a GFI outlet.
The Door Open alarm is active.	Door is not closed completely.	Close door.
	Door switch or wiring connection is faulty.	Check wiring and continuity of switch contacts. Replace the door switch if necessary.
Alarm is active, but not audible.	Key switch is in the OFF position	Turn key switch to ON position.
Battery alarm is active. (ER06)	Backup battery is depleted, not installed, or not connected.	Replace or install 9V backup battery.

13.4 Condensation Problems

Problem	Possible Cause	Action
Excess condensation/moisture inside chamber.	Stored liquid spilled within the chamber.	Verify stored liquid products are properly sealed. Clean chamber.
	Unit cooler condensation pan is not draining.	Ensure refrigerator and unit cooler pan are level. Level if necessary for proper gravity fed drainage.
		Check drain line for debris. Flush drain line if necessary.
	Door was open for an extended time.	Close door and allow chamber to stabilize
	Door seal is deficient.	Inspect door seal for damage. Replace seal if necessary.
		Check for wires routed through the door seal. Reroute wires through available access port if necessary.
Check through holes and ensure they are sealed. Reseal if necessary.		

Horizon Series

14 Horizon Series Parts

Notes

- Before replacing parts, protect items in refrigerator from extended exposure to adverse temperature.
- Allow refrigerator temperature to stabilize at setpoint after replacing parts or after extended door opening.
- Circuit boards are sensitive to static electricity and can be damaged by electrostatic discharge. Use proper ESD precautions when handling the board.



Letter	Description	Model	Part Number	Letter	Description	Model	Part Number	Volt
A	Membrane	-	370225-1	K	Probe Bottle/Ballast Holder	113/120	320756-4	-
B	Display Circuit Board Assembly	-	801016-1			125-		-
C	Ventilated Shelf	113	401956-1-069	L	Ventilated Drawer (includes slides)	113	401963-1-069	-
		120/245	402052-1-069			120/245	402042-1-069	-
		125/256	402053-1-069			125/256	402043-1-069	-
D	Solid Drawer (includes slides)	113	401966-1-000	M	Solid Ballast	-	402062-1	-
		120/245	400370-3	N	Temperature Chart Recorder (TCR)	-	800025-1	115
		125/256	400370-4			-	800025-2	230
E	Caster	-	220467	O	TCR Stylus Arm (with pen)	-	400505-1	-
F	Access Control Keypad	-	120612	P	Chart Paper (52 sheets)	-	220366	-
G	Alarm ON/OFF Key Switch	-	120984	Not shown	TCR Backup Battery (9V)	-	120218	-
H	Light Switch	-	120202	Not shown	Chart Recorder Probe	-	800024-1	-
I	Primary Monitor Probe	-	801017-1					
J	Probe Bottle (with Glycerin)	-	400922-1					

NOTICE

Disconnect unit from AC power when removing and replacing LED lamps.

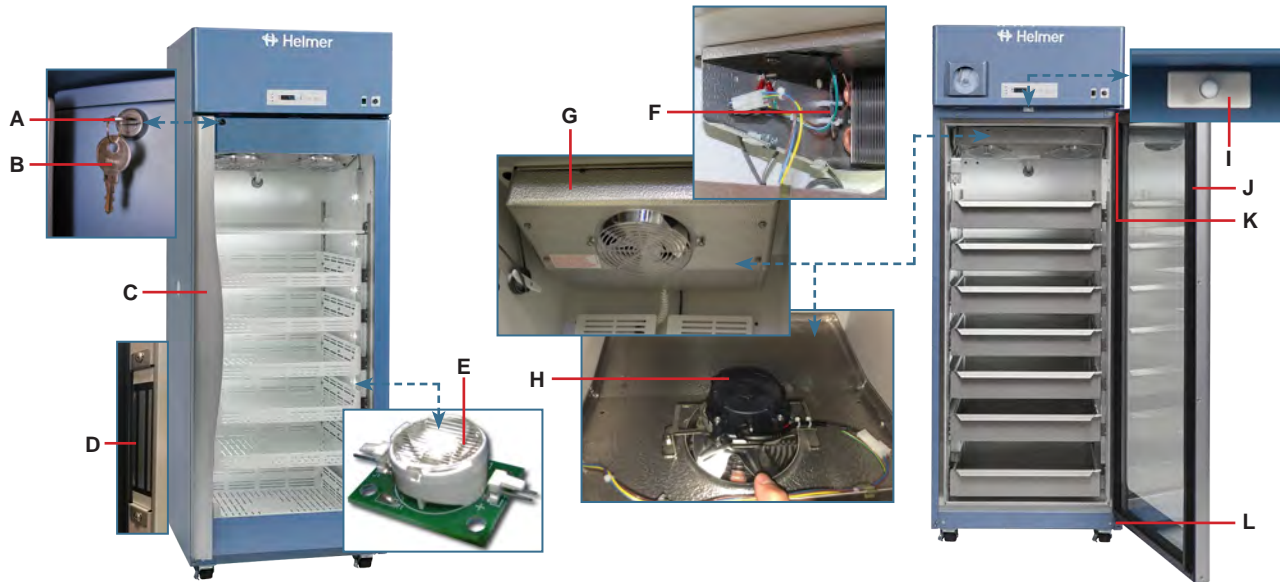

Letter	Description	Model	Part Number	Letter	Description	Model	Part Number
A	Door Lock	-	220540	G	Unit Cooler Assembly	113	800980-1
B	Door Lock Key	-	220630			120/125	801051-1
C	Door Handle	113	321096-1			245/256	801054-1
		120/125/245/256	320683-1	H	Unit Cooler Fan Motor	113/120/125	800995-1
D	Magnetic Lock (solid door)	-	801000-1			245/256	800995-1
	Magnetic Lock (glass door)	-	801000-2	I	Door switch	-	120380
E	LED Lamp (5 lights; powder coat)	113	800914-1	J	Door Gasket	113	321082-1
	LED Lamp (5 lights; powder coat)	120/125	401005-1			120/125/245/256	321271-1
	LED Lamp (7 lights; powder coat)	120/125	401002-1	K	Upper Hinge Assembly (Left)	-	400975-2-067
	LED Lamp (10 lights; powder coat)	245/256	401003-1		Upper Hinge Assembly (Right)	-	400975-1-067
	LED Lamp (14 lights; powder coat)	245/256	401004-1		L	Lower Hinge Assembly (Left)	-
F	Control Probe	-	801018-1	Lower Hinge Assembly (Right)		-	401825-1-067

Horizon Series



Risk of fire or explosion. Flammable refrigerant used. To be repaired only by trained service personnel. DO NOT puncture refrigerant tubing.

NOTICE

- Disconnect unit from AC power before opening the electrical box.

Note

Circuit boards are sensitive to static electricity and can be damaged by electrostatic discharge. Use proper ESD precautions when handling the board.

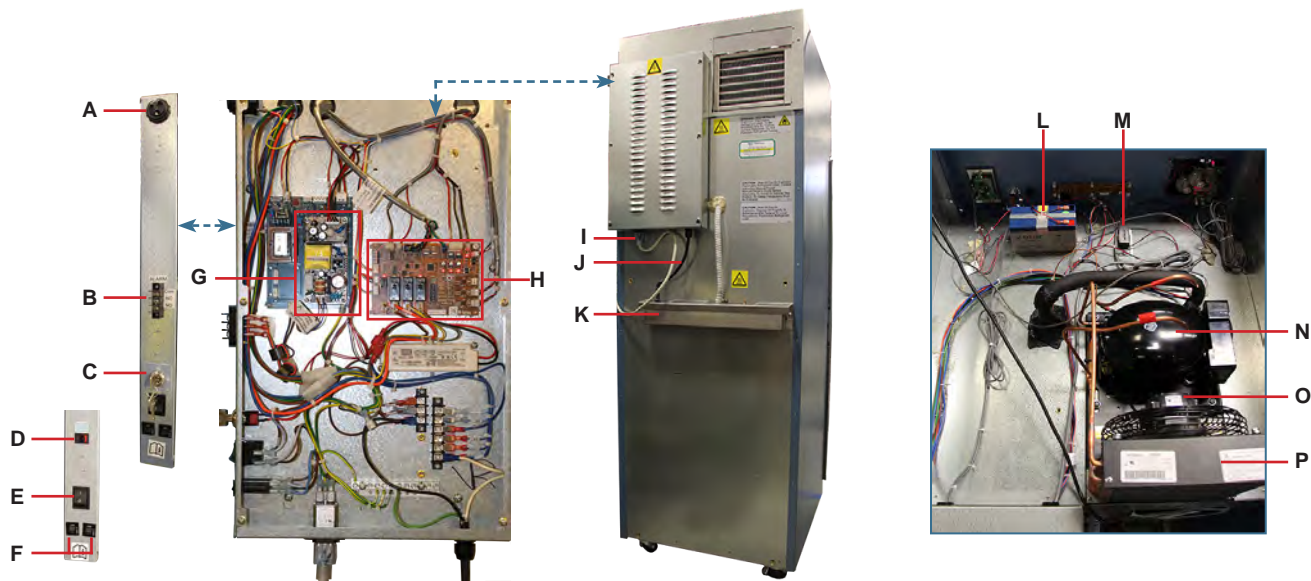

Letter	Description	Part Number	Volts	Letter	Description	Model	Part Number	Volts
A	Audible Alarm	120160	-	L	Backup Battery (optional Access Control)		121018	-
B	Remote Alarm Contacts	120404	-	M	Monitoring System Backup Battery		-	-
C	Backup Battery Key Switch (with Access Control)	120754	-	N	Compressor		-	-
D	Backup Battery Switch (no Access Control)	120202	-	O	Condenser Fan Motor	113	800996-1	-
E	Main Power Switch	120478	-			120/125 245/256	801058-1	-
F	Circuit Breakers	120272	-	P	Condensing Unit	113	800992-1	115
G	Power Supply Board (no Access Control)	120627	-			113	801014-1	230
	Power Supply Board (with Access Control)	800916-1	-			120/125	801052-1	115
H	Control Board	801015-1	-			120/125	801053-1	230
I	Power Cord	120630	-			245/256	801055-1	115
J	Condensate Heater Assembly	401901-1	115		245/256	801056-1	230	
		401901-2	230					
K	Condensate Evaporator Tray	-	-					

15 Schematics

15.1 HBR, HLR and HPR Mode

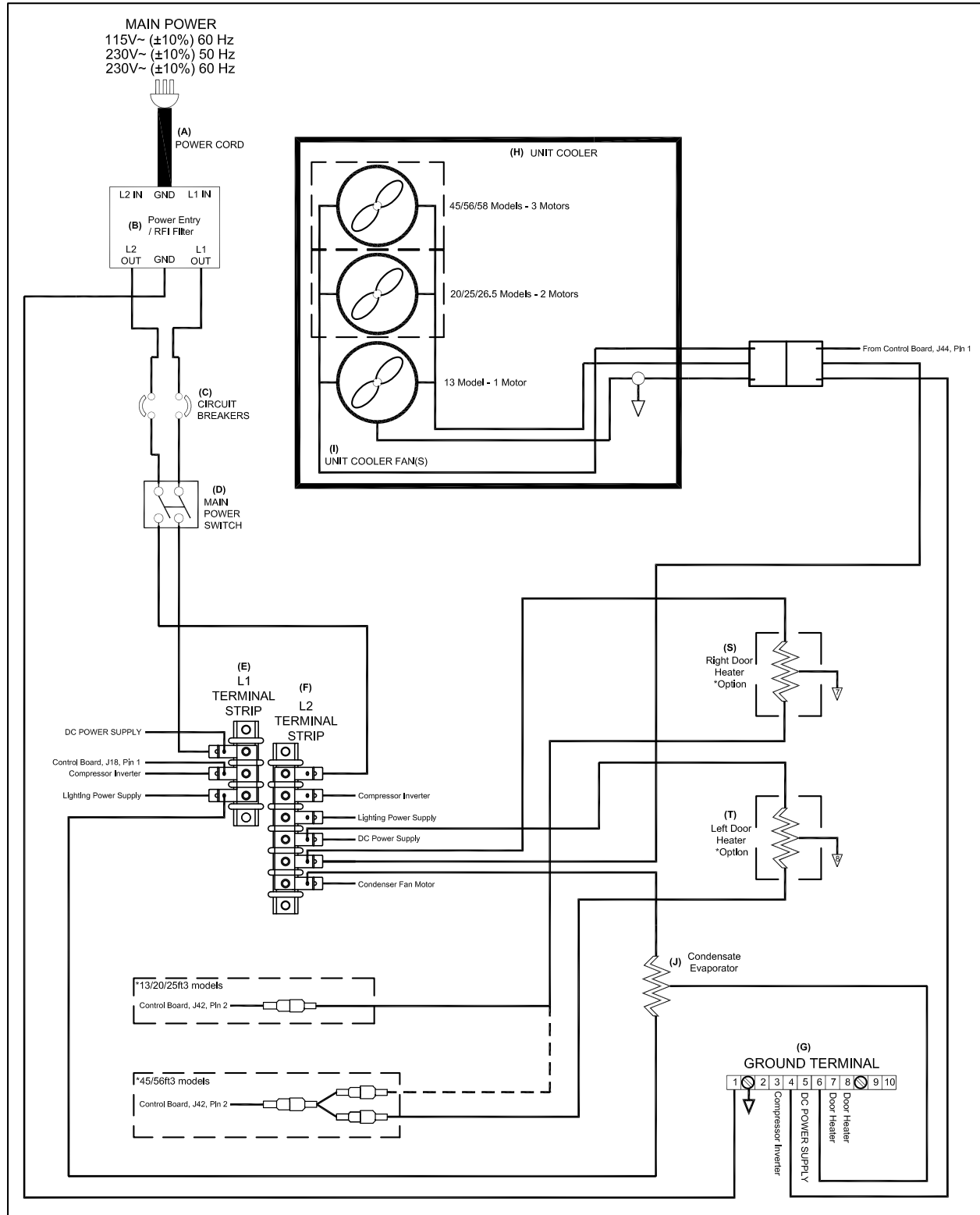

THESE DRAWINGS AND SPECIFICATIONS ARE THE SOLE PROPERTY OF HELMER INC. AND SHALL NOT BE REPRODUCED OR USED AS THE BASIS FOR MANUFACTURE OR SALES OF APPARATUS WITHOUT THE APPROVAL OF HELMER INC. ALL PARTS ARE REQUIRED TO BE ROHS COMPLIANT AND MUST MAINTAIN CERTIFICATE OF COMPLIANCE.

Horizon Series

15.2 HBR, HLR and HPR Models (without Access Control)

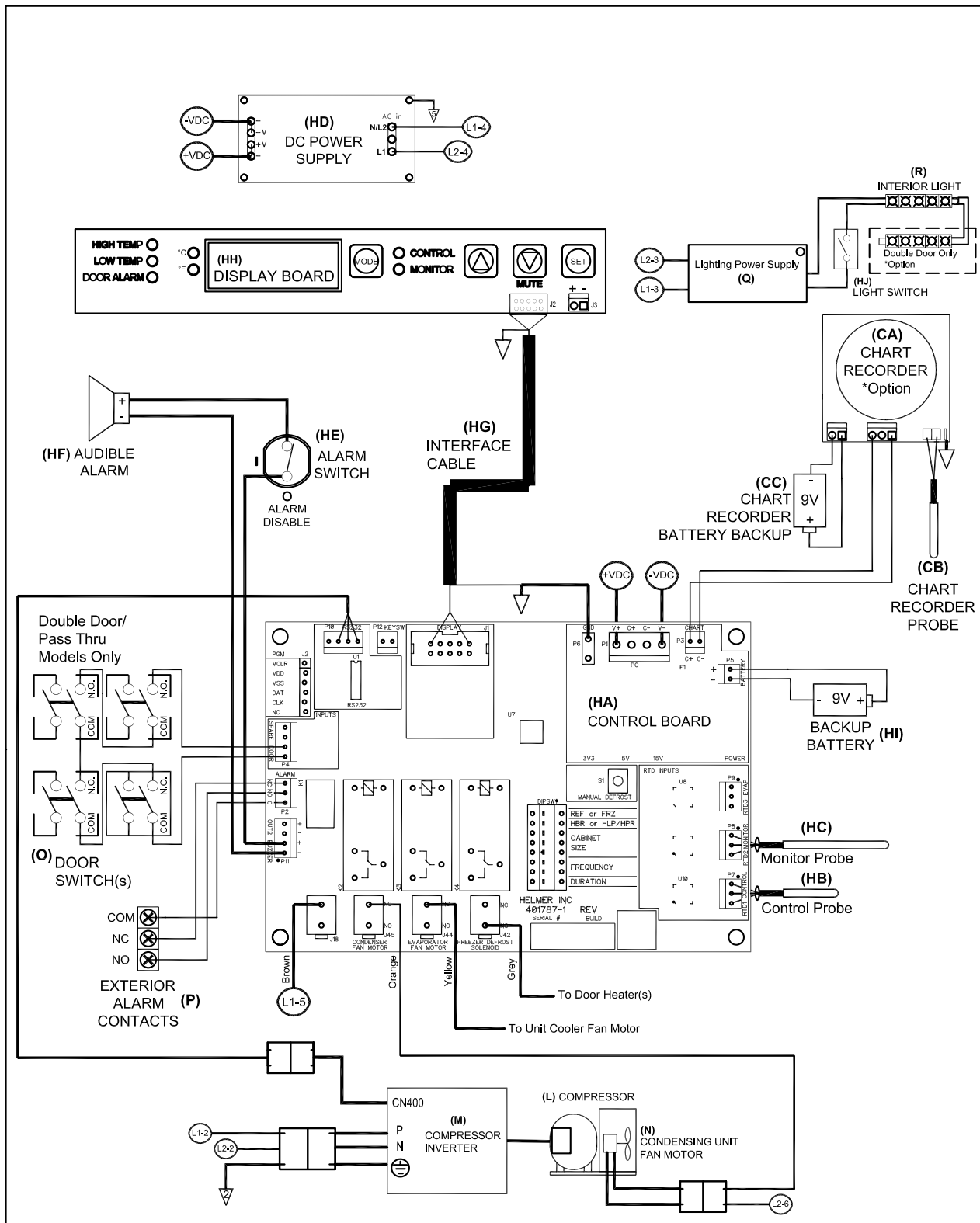

THESE DRAWINGS AND SPECIFICATIONS ARE THE SOLE PROPERTY OF HELMER INC. AND SHALL NOT BE REPRODUCED OR USED AS THE BASIS FOR MANUFACTURE OR SALES OF APPARATUS WITHOUT THE APPROVAL OF HELMER INC. ALL PARTS ARE REQUIRED TO BE ROHS COMPLIANT AND MUST MANTAIN CERTIFICATE OF COMPLIANCE.

Horizon Series

15.3 HBR, HLR and HPR Models (with Access Control)

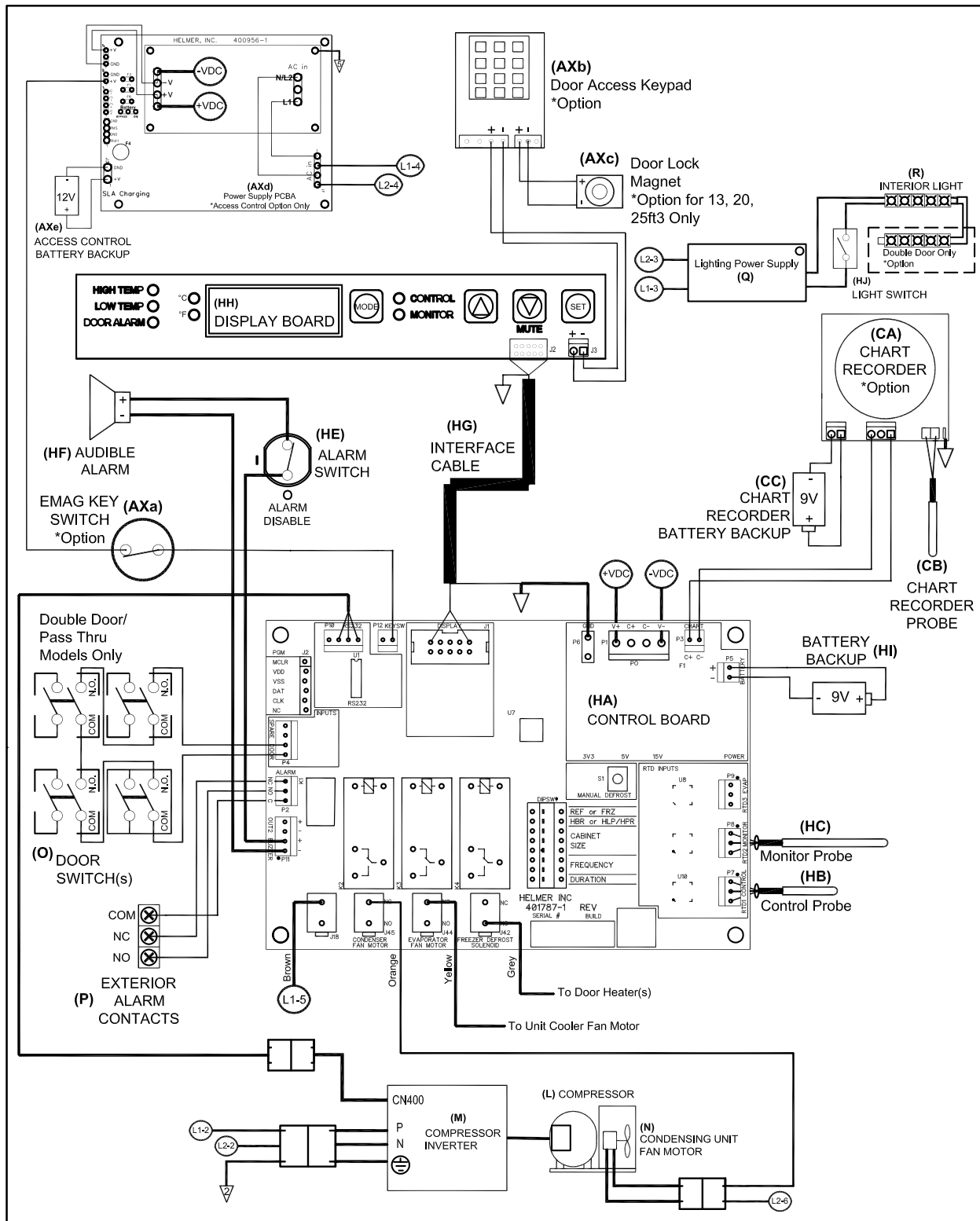

Horizon Series

THESE DRAWINGS AND SPECIFICATIONS ARE THE SOLE PROPERTY OF HELMER INC. AND SHALL NOT BE REPRODUCED OR USED AS THE BASIS FOR MANUFACTURE OR SALES OF APPARATUS WITHOUT THE APPROVAL OF HELMER INC. ALL PARTS ARE REQUIRED TO BE ROHS COMPLIANT AND MUST MAINTAIN CERTIFICATE OF COMPLIANCE.

Appendix A: Warranty

Rel.i™ Product Warranty USA and Canada

For technical service needs, please contact Helmer at 800-743-5637 or www.helmerinc.com. Have the model and serial number available when calling.

Rapid Resolution

When a warranty issue arises it is our desire to respond quickly and appropriately. The service department at Helmer is there for you. Helmer will oversee the handling of your warranty service from start to finish. Therefore, Helmer must give advance authorization for all service calls and/or parts needs relating to a warranty issue. Any repeat service calls must also be authorized as well. This allows for proper diagnosis and action. Helmer will not be responsible for charges incurred for service calls made by third parties prior to authorization from Helmer. Helmer retains the right to replace any product in lieu of servicing it in the field.

Compressor

For the warranty period listed below, Helmer will supply the refrigeration compressor, if it is determined to be defective, at no charge, including freight. Helmer will not be liable for installation, refrigerant, or miscellaneous charges required to install the compressor beyond the first year of the warranty period.

- ◆ i.Series model compressor warranty period is seven (7) years.
- ◆ Horizon Series model compressor warranty period is five (5) years.

Parts

For a period of two (2) years, Helmer will supply at no charge, including freight, any part that fails due to defects in material or workmanship under normal use, with the exception of expendable items. Expendable items such as glass, filters, light bulbs, and door gaskets are excluded from this warranty coverage. Inspection of defective parts by Helmer will be final in determining warranty status. Warranty procedures must be followed in all events.

Labor

For a period of one (1) year, Helmer will cover repair labor costs (including travel) and the cost of refrigerant and supplies necessary to perform authorized repairs. Repair service must be performed by an authorized Helmer service agency following the authorization process detailed above. Alternatively, your facility's staff may work with a Helmer technician to make repairs. Labor costs for repairs made by unauthorized service personnel, or without the assistance of a Helmer technician, will be the responsibility of the end user.

Additional Warranty Information

The time periods set forth above begin two (2) weeks after the original date of shipment from Helmer. Warranty procedures set forth above must be followed in all events.

THERE ARE NO WARRANTIES WHICH EXTEND BEYOND THE DESCRIPTION ON THE FACE HEREOF. THIS WARRANTY IS EXCLUSIVE AND IN LIEU OF ALL OTHER WARRANTIES, EXPRESS OR IMPLIED, INCLUDING WITHOUT LIMITATION ANY WARRANTY OF MERCHANTABILITY OR FITNESS FOR A PARTICULAR PURPOSE. NO WARRANTIES OF MERCHANTABILITY OR FITNESS FOR PARTICULAR PURPOSE SHALL APPLY.

THE LIABILITY, IF ANY, OF HELMER FOR DIRECT DAMAGES WHETHER ARISING FROM A BREACH OF ANY SALES AGREEMENT, BREACH OF WARRANTY, NEGLIGENCE, OR INDEMNITY, STRICT LIABILITY OR OTHER TORT, OR OTHERWISE WITH RESPECT TO THE GOODS OR ANY SERVICES IS LIMITED TO AN AMOUNT NOT TO EXCEED THE PRICE OF THE PARTICULAR GOODS OR SERVICES GIVING RISE TO THE LIABILITY. IN NO EVENT SHALL HELMER BE LIABLE FOR ANY INDIRECT, INCIDENTAL, CONSEQUENTIAL, OR SPECIAL DAMAGES, INCLUDING WITHOUT LIMITATION DAMAGES RELATED TO LOST REVENUES OR PROFITS, OR LOSS OF PRODUCTS.

This warranty does not cover damages caused in transit, during installation by accident, misuse, fire, flood, or acts of God. Further, this warranty will not be valid if Helmer determines that the failure was caused by a lack of performing recommended equipment maintenance (per Helmer manual) or by using the product in a manner other than for its intended use. Installation and calibration are not covered under this warranty agreement.

Outside of USA and Canada

Consult your local distributor for warranty information.

END OF MANUAL

