

Application, Rating, & Electrical Data	
Application	High performance storage of medical and scientific products
Storage Volume	56 cu ft 1586 L
Temperature Range	+2°C to +10°C
Set Point	+5°C
Electrical Power	115V 60Hz 220-240V 50/60Hz
Maximum Current	4.3A 2.5A
Facility Supply Rating	Branch circuit with earth ground, meeting plug/cord ratings as well as local electrical safety codes and requirements 110-120V AC: 15 A (minimum) 220-240V AC: 10 A (minimum)
Power Plug/Power Cord Length	NEMA 5-15 hospital-grade 115V 60Hz, 8 to 10 ft (2.4-3.0m) Inquire about additional plug/cord options
Certification/Agency Listing	QPS (Certified to UL and CSA Standards) IEC/UL61010-2-011: 2016 IEC 61010-1:2010, AMD1:2016 ETL certified to NSF/ANSI 456 Vaccine Storage Standard
Energy Star	Yes, ENERGY STAR® Certified High Performance Refrigerator
Indoor/Outdoor Use	Indoor use only, non-residential
Application Environment	Non-corrosive, non-flammable, non-explosive
Ambient Operating Temperature	+15°C to +32°C +59°F to +90°F
Refrigeration	
Refrigeration System	VCC compressor-based, forced-air hydrocarbon
Compressor	Hermetic, variable speed (VCC). Rated speed range: 1300-4000 rpm
Condenser Type	Air-cooled fin and tube, sealed
Expansion Device	Cap tube
Evaporator Type	Direct expansion with forced-air fin and tube
Defrost Method	Automatic
Refrigerant	R600a, Isobutane, EPA SNAP compliant
Controller / Configuration Settings	
User Interface	LED digital display, °C or °F
Power Switch	On/Off
Controller Type	Microprocessor with alarm/monitor
Security	Lockable doors
Control Sensor	RTD, stainless steel
Communication Ports	Remote alarm contacts
Power Failure Alarm	Yes
High/Low Alarms	Yes, fully adjustable
Door Ajar Alarm	Yes
Min/Max Temperature	Yes, display and reset
Temperature Monitoring Ballast	Yes, 4 oz bottle with screw cap, solid ballast optional
Battery Back-up	Yes, 9V, non-rechargeable, lithium

Performance Characteristics	
Uniformity °C	+/-1.0
Recovery to 8°C after 3 min door opening min	10
Stability °C	0.06
Energy Consumption kWh/day	3.87
Noise emission dB	52
Heat Rejection / Emission BTU/hr	1195
Pull-down time to 5°C min	46

All performance data from 56 cu ft refrigerator, 24.8°C ambient, 5.0°C. Meets temperature performance requirements as included in NSF/ANSI 456 Vaccine Storage Standard.

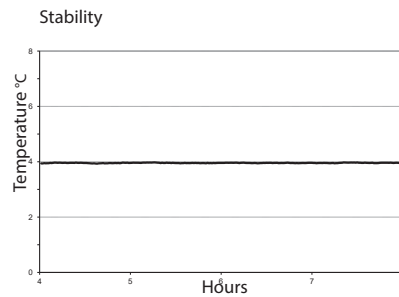
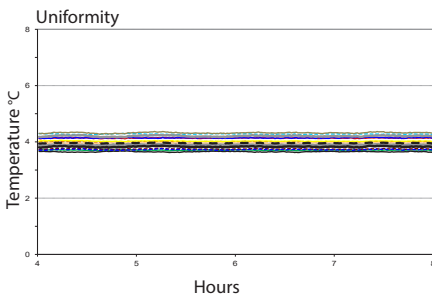
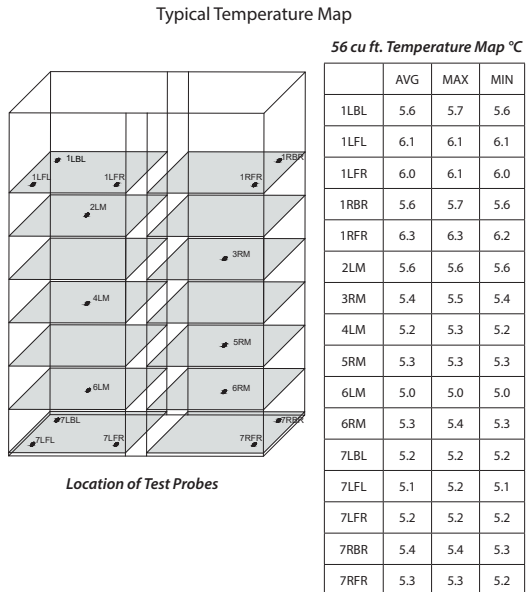
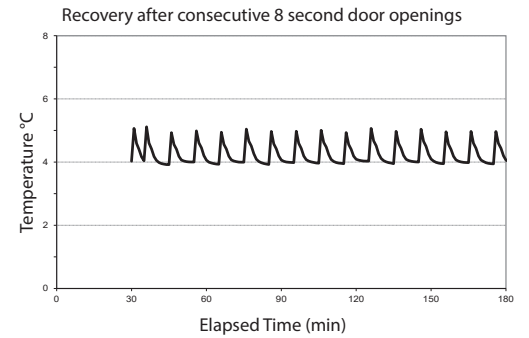

Dimensions and Construction	
Interior (w x h x d)	54.7 x 58.1 x 30 in 1390 x 1476 x 762 mm
Exterior (w x h x d)	59 x 78.9 x 34.1 in 1499 x 2003 x 865 mm
Overall Exterior (w x h x d)	59 x 78.9 x 39.1 in 1499 x 2003 x 993 mm *Includes handles and electrical box *subtract 0.2" from depth for units prior to serial number 2150000
Insulation	Sustainable, US EPA and SNAP approved foam
Exterior/Interior Finish	Bacteria-resistant powder-coating
Door	2, dual-pane glass
Access Port	Top Access Port - for external monitoring probe(s) (0.75 in 19 mm diameter) Left Sidewall Port - with interior and exterior plugs (1.75 in 45 mm diameter)
Interior Storage (w x h x d)	2 ventilated, powder coated shelves, adjustable 22.5 x 27.9 in 572 x 709 mm, 100 lb 46 kg max capacity/shelf 12 ventilated, powder coated, pull-out drawers 21.5 x 3.9 x 28 in 546 x 100 x 713 mm, 100 lb 46 kg max capacity/drawer
Casters	Yes, swivel-locking
Net Weight	817 lb 371 kg
Shipping Weight	947 lb 430 kg
Clearance Requirements	Minimum of 8" (203mm) above and 3" (76mm) behind unit for proper ventilation, clearance, and feature access
Options Accessories	Stainless steel interior, Chart recorder, Chart paper, Leveling feet, Solid ballast, Remote alarms, Floor and Wall bracket kit, Seismic anchoring kit, Storage trays, Locking drawer, Solid or heated glass doors, Top cover, Side-wall access ports, Temperature validation, Validation guide (IQ/OQ), Extended warranty
Certificate of Calibration	Yes, generated with ISO 17025 certified, NIST traceable thermometer
Warranty	Rel.i™ Warranty- 5 years compressor, 2 years parts, 1 year labor Outside US and Canada- Contact your distributor for warranty information

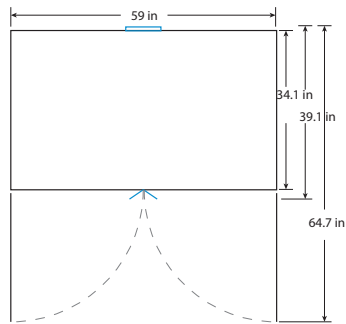

TOP VIEW

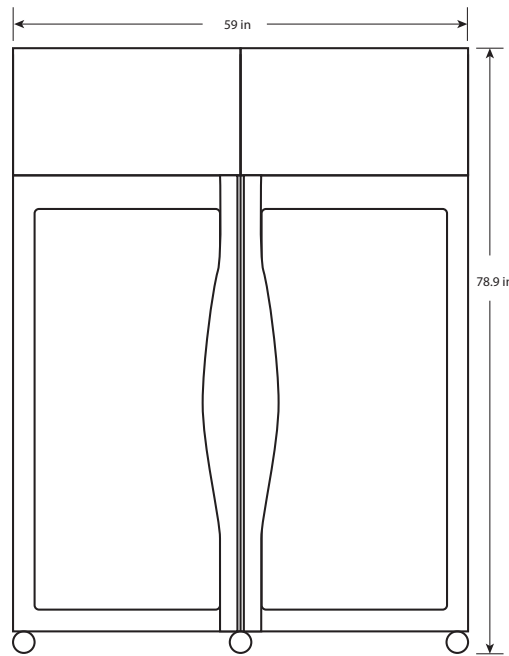

FRONT VIEW

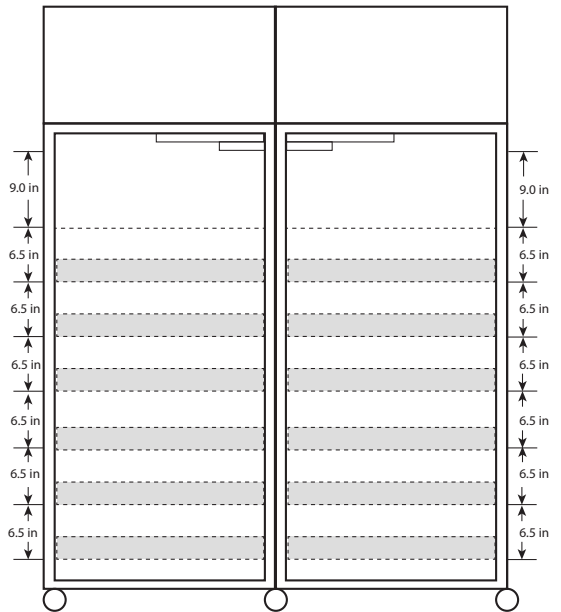

INTERIOR VERTICAL SPACING

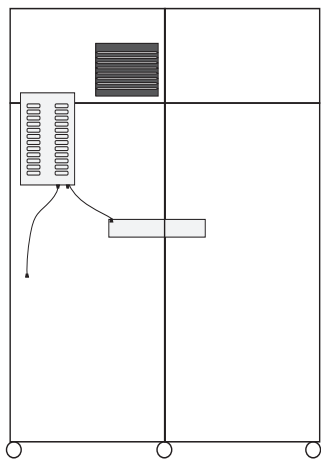

BACK VIEW