



Helmer Scientific, Noblesville, Indiana  
www.helmerinc.com

# Technical Data Sheet

## High-Performance, Medical-grade Refrigerator

Model: iLR105-GX, i.Series® Laboratory / Undercounter

Application, Rating, & Electrical Data	
Application	High-performance storage of medical and scientific products
Storage Volume	5.3 cu ft (150 L)
Temperature Range	+2°C to +10°C
Set Point	4°C
Electrical Power	115V 60Hz   220-240V 50/60Hz
Maximum Current	1.4A   0.85A
Building Supply Rating	15A dedicated ground circuit
Power Plug/Power Cord Length	NEMA 5-15 hospital-grade   115V 60Hz, 8 to 10 ft (2.4-3.0m) CEE 7/7(Schuko)   230V 50Hz, 8 to 10 ft (2.4-3.0m) NEMA 6-15 hospital-grade   230V 60Hz, 8 to 10 ft (2.4-3.0m)
Certification/Agency Listing	QPS (Certified to UL and CSA Standards) IEC/UL61010-2-011 (Dec 2016)
Energy Star	Yes
ADA Compliant	Yes, fits under standard 36" high ADA compliant countertop
Indoor/Outdoor Use	Indoor Use Only
Application Environment	Non-corrosive, non-flammable, non-explosive
Ambient Operating Temperature	15°C to 32°C   59°F to 90°F
Refrigeration	
Refrigeration System	VCC compressor-based, forced-air hydrocarbon
Compressor	Hermetic, variable speed (VCC). Rated speed range: 1300-4000 rpm
Condenser Type	Air-cooled fin and tube, sealed
Expansion Device	Cap tube
Evaporator Type	Direct expansion with forced circulation fin and tube
Defrost Method	Automatic
Refrigerant	R600a, Isobutane, EPA SNAP compliant
Controller / Configuration Settings	
User Interface	i.C3® color touchscreen, door-mounted, 7 in   177 mm
Power Switch	On/Off
Controller Type	Microprocessor with touchscreen input & display, includes USB port for data retrieval
Security	Lockable door, password protected settings, PIN access via optional access control
Control Sensor	RTD, stainless steel
Communication Ports	USB, Ethernet, Remote alarm connections
Power Failure Alarm	Yes
High/Low Alarms - Tests	Yes, fully adjustable, automatic (Peltier) testing
Door Ajar Alarm	Yes, fully adjustable
Condenser Temperature Alarm	Yes, fully adjustable
Min/Max Temperature	Yes, display and reset
Download	Yes, via USB or Ethernet API
Event Log	Yes, all alarms, door openings, download via USB
Temperature Log	Yes, download via USB
Access Log	Yes, with optional access control, download via USB
Interactive Temperature Graph	Yes
Temperature Monitoring Ballast	Yes, 4 oz bottle with screw cap, solid monitoring ballast optional

Performance Characteristics (normal operating conditions)	
Uniformity   °C	+/-1.0
Recovery to 7°C after 3 min door opening   min	11
Stability   °C	0.82
Energy Consumption   kWh/day	1.37
Noise emission   dB	42
Heat Rejection   BTU/hr	460
Pull-down time   min	36

All performance data from 5 cu ft refrigerator, 24.8 ambient, 4.0°C

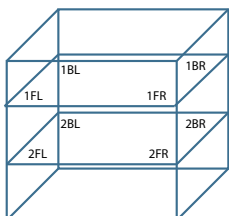
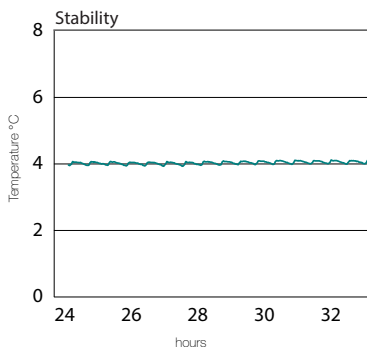
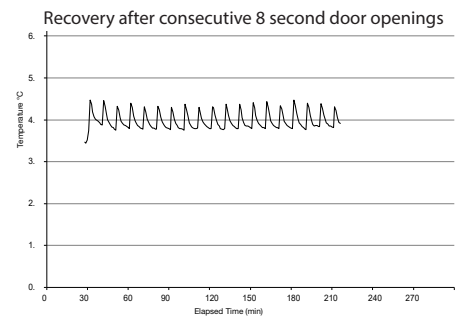
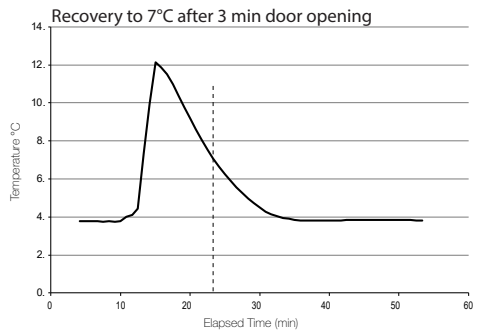
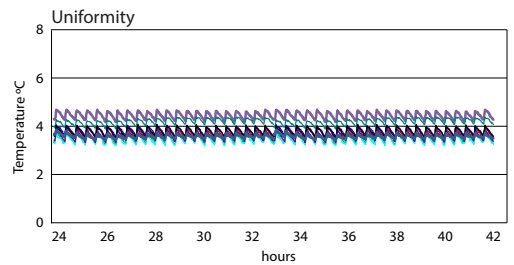

Location of test probes

### Typical Temperature Map

#### 5 cu ft. Temperature Map (°C)

	1FL	1FR	1BL	1BR	2FL	2FR	2BL	2BR
Avg	4.0	3.9	3.6	3.5	4.3	3.9	4.4	3.8
Max	4.5	4.3	4.2	4.2	4.5	4.3	4.7	4.3
Min	3.7	3.5	3.2	3.1	4.0	3.5	4.1	3.4

Dimensions and Construction	
Interior (w x h x d)	19.5 x 19.9 x 22.8 in   496 x 505 x 580 mm
Exterior (w x h x d)	24 x 31.5 x 26.7 in   610 x 798 x 678 mm
Overall Exterior (w x h x d)	24 x 31.9 x 28.1 in   610 x 809 x 714 mm (Inc. leveling feet, door handle, user interface)
Insulation	Sustainable, US EPA, SNAP and GRAS approved foam
Exterior/Interior Finish	Bacteria-resistant powder-coating
Door	Solid, field-reversible
Access Port	Rear access port
Interior Storage	2 ventilated shelves, adjustable 17.9 x 21.3 in   454 x 541 mm, 100 lb   46kg max capacity/shelf
Leveling Feet	Yes, adjustable
Integrated Access Control	Optional - electromagnetic-lock via i.C3® user interface PIN
Net Weight	174 lb   79 kg
Shipping Weight	235 lb   107 kg
Clearance Requirements	Minimum 3 in (76 mm) behind unit for clearance and feature access
Options   Accessories	Glass door, LED light, Integrated access control, Stainless steel exterior/interior, TCR2 chart recorder, Swivel, locking casters, Solid ballast, Remote alarms, Stacking kit, Floor and Wall bracket kit, Storage trays, Pedestal, Locking drawer, Certificate of Calibration, Temperature Validation, Validation Guides (IQ/OQ), Extended Warranty

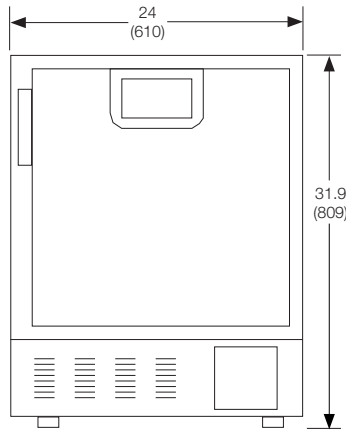

FRONT VIEW

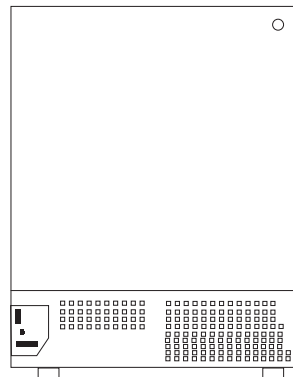

BACK VIEW

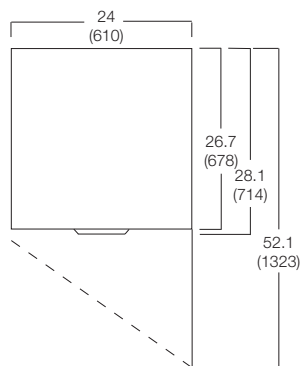

TOP VIEW

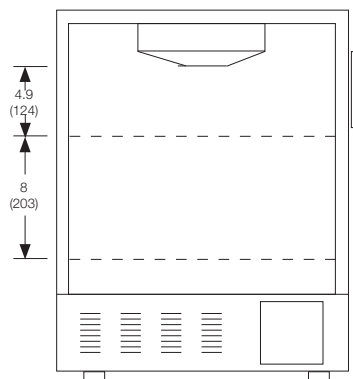

INTERIOR  
VERTICAL SPACING